

Rittal – The System.

Faster – better – everywhere.

LCP DX 35
LCP DX/FC 35



3311.450
3311.460
3311.470
3311.480

Assembly and operating instructions

ENCLOSURES

POWER DISTRIBUTION

CLIMATE CONTROL

IT INFRASTRUCTURE

SOFTWARE & SERVICES

FRIEDHELM LOH GROUP



Foreword

Foreword

Dear Customer!

Thank you for choosing a Rittal Liquid Cooling Package DX (referred to hereafter also as "LCP DX").

This documentation applies to the following devices in the LCP DX series:

- LCP Inline DX
- LCP Inline DX with option "Free Cooling" (LCP DX/FC)

Those sections where information only applies to one of the two units are labelled accordingly in the documentation.

Please take the time to read this documentation carefully and pay particular attention to the safety instructions in the text and to section 2 "Safety instructions".

This is the prerequisite for:

- secure assembly of the LCP DX
- safe handling and
- the most trouble-free operation possible.

Please keep the complete documentation readily available so that it is always on hand when needed.

We wish you every success!

Your,
Rittal GmbH & Co. KG

Rittal GmbH & Co. KG
Auf dem Stützelberg

35745 Herborn
Germany

Tel.: +49(0)2772 505-0
Fax: +49(0)2772 505-2319

E-mail: info@rittal.de
www.rittal.com
www.rittal.de

We are always happy to answer any technical questions regarding our entire range of products.

Contents

1	Notes on documentation	5	6.2	Coolant circuit	22
1.1	CE labelling	5	6.2.1	General	22
1.2	Information on electromagnetic compatibility	5	6.2.2	Notes on pipework	22
1.3	Storing the documents	5	6.3	Cooling water circuit (LCP DX/FC only)	26
1.4	Symbols in these operating instructions	5	6.3.1	General	26
1.5	Other applicable documents	5	6.3.2	Notes on pipework	26
1.6	Normative instructions	5	6.3.3	Determining the quantity of water/glycol	26
1.6.1	Legal information concerning the operating instructions	5	6.3.4	Connecting the pipework	26
1.6.2	Copyright	5	6.3.5	Filling the cooling water circuit	26
1.6.3	Revision	5	6.4	Connecting the condensate discharge	27
2	Safety instructions	6	6.5	Electrical connection	28
2.1	Important safety instructions:	6	6.5.1	General	28
2.2	Service and technical staff	7	6.5.2	Connecting the power supply	28
2.2.1	Personal safety equipment	7	6.5.3	Connecting the external condenser (LCP DX only)	29
2.3	Operator requirements	7	6.5.4	Electrical connection of the condenser for indirect free cooling (LCP DX/FC only)	29
2.3.1	Abbreviated instructions	7	6.6	Checking the entire system prior to commissioning	31
2.3.2	System log	7	7	Operation	32
2.3.3	F-gas regulation	7	7.1	Control and display components	32
2.3.4	Chemicals – Climate Protection Ordinance	8	7.2	Switching the LCP DX on and off	32
2.4	RoHS compliance	8	7.2.1	Switching on the LCP DX and the external condenser	32
3	Device description	9	7.2.2	Switching off the LCP DX and the external condenser	32
3.1	General functional description	9	7.2.3	Switching off in an emergency	32
3.1.1	LCP DX	9	7.3	Layout of the user interface	32
3.1.2	LCP DX/FC	9	7.4	General operating instructions	32
3.2	Air routing	10	7.4.1	Moving between menus	32
3.3	Equipment assembly	10	7.4.2	Changing parameter values	32
3.3.1	Unit components	10	7.5	Start screen	32
3.3.2	Coolant circuit	11	7.6	Menu level A "On/Off Unit"	33
3.3.3	Water circuit (LCP DX/FC only)	12	7.6.1	Menu A01	33
3.3.4	External condenser	12	7.6.2	Menu A02	33
3.3.5	Fan module	12	7.7	Menu level B "Setpoint"	33
3.4	Proper and improper usage	13	7.7.1	Menu B01	33
3.5	Supply scope of a LCP DX	13	7.7.2	Menu B02	33
4	Transportation and handling	14	7.8	Menu level C "Clock/Scheduler"	34
4.1	Transportation	14	7.8.1	Menu C01	34
4.2	Unpacking	14	7.8.2	Menu C02 – C04	34
5	Assembly and siting	15	7.8.3	Menu C05	34
5.1	General	15	7.9	Menu level D "Input/Output"	34
5.1.1	Installation site requirements	15	7.9.1	Menu D01 – D06	34
5.1.2	Prepare the installation room	16	7.9.2	Menu D07 – D12	34
5.1.3	Installation guidelines	16	7.9.3	Menu D13	34
5.2	Assembly procedure	17	7.9.4	Menu D14	34
5.2.1	General	17	7.9.5	Input/output menu	34
5.2.2	Fit the attenuators	17	7.10	Menu level E "Data logger"	34
5.2.3	Dismantle the side panels	17	7.10.1	Menu E01	34
5.2.4	Seal the server enclosure	17	7.11	Menu level F "Board switch"	34
5.2.5	Dismantle the server enclosure door	18	7.12	Menu level G "Service"	35
5.2.6	Installation and baying of the LCP DX	19	7.12.1	Menu Ga "Change language"	35
5.2.7	Mounting the side panel	20	7.12.2	Menu Gb "Information"	35
5.3	External condenser	20	7.12.3	Menu Gd "Working hours"	35
6	Installation	22	7.13	Configure the pCO Web card	35
6.1	General	22	7.13.1	Activate the factory bootswitch parameters	35
			7.13.2	Logging on to the pCO Web card	36

Contents

7.13.3	Configure the network interface	36	15.8	Redundancy	65
7.13.4	E-mail configuration	37	15.8.1	General information	65
7.13.5	LCP DX supervisory table	38	15.8.2	Installation	65
8	Troubleshooting	45	15.8.3	Activating the redundancy	65
8.1	General	45	15.8.4	Installation prerequisites	66
8.2	Alarm relay circuit (general alarm)	45	16	Further technical information	67
8.3	List of error messages and solutions	46	16.1	Coolant information	67
9	Inspection and maintenance	49	16.2	Information about cooling water (LCP DX/FC only)	67
9.1	Safety instructions concerning maintenance work	49	16.3	Cooling output	67
9.2	Cleaning the heat exchanger	49	16.3.1	General	67
9.3	Fan replacement	49	16.3.2	LCP DX	68
9.4	Check the cooling water circuit (LCP DX/FC only)	50	16.3.3	LCP DX/FC	70
10	Storage and disposal	51	16.4	Overview drawing	73
11	Technical specifications	52	16.5	Piping and instrumentation diagram to DIN EN 1861:1998	80
11.1	TopTherm LCP Inline DX	52	16.5.1	LCP DX	80
11.2	TopTherm LCP Inline DX/FC	53	16.5.2	LCP DX/FC	82
11.3	Standard condenser unit	54	16.6	Characteristic curve of cooling water pump	86
11.4	Condenser unit for indirect free cooling	55	16.7	Circuit diagram	87
11.5	High temperature condenser	56	17	Glossary	88
11.6	Coolant fill volume	56	18	Customer service addresses	89
11.7	Refrigerant pipes	57			
12	Spare parts	58			
13	Accessories	59			
14	SNMP card	60			
15	Options	61			
15.1	General information	61			
15.2	Humidifier	61			
15.2.1	General information	61			
15.2.2	Activating the humidifier	61			
15.2.3	Setting the humidity setpoint	61			
15.2.4	Technical specifications	61			
15.2.5	Installation prerequisites	62			
15.3	Electrical heaters	62			
15.3.1	General information	62			
15.3.2	Activating the heaters	62			
15.3.3	Technical specifications	63			
15.4	Dehumidification	63			
15.4.1	General information	63			
15.4.2	Activating the dehumidification	63			
15.4.3	Installation prerequisites	64			
15.5	Condensate pump	64			
15.5.1	General information	64			
15.5.2	Technical specifications	64			
15.5.3	Installation	64			
15.6	High temperature condenser	64			
15.6.1	General information	64			
15.6.2	Installation prerequisites	65			
15.7	Air filter	65			
15.7.1	General information	65			
15.7.2	Setting the threshold	65			
15.7.3	Maintenance	65			

1 Notes on documentation

1.1 CE labelling

Rittal GmbH & Co. KG hereby confirms that the cooling units in the LCP DX series are compliant with the EMC Directive 2014/30/EC as well as with the Machinery Directive 2006/42/EC. A corresponding declaration of conformity has been issued and enclosed with the documentation package supplied with the unit.

The cooling unit bears the following mark.



1.2 Information on electromagnetic compatibility

The LCP DX is a class A device as defined by EN 55022. Under certain circumstances, the device may cause radio interference in domestic environments. In such cases, the operator may be asked to implement appropriate measures.

1.3 Storing the documents

The assembly and operating instructions as well as all applicable documents are integral components of the product. They must be handed to those persons who are engaged with the unit and must always be available and on hand for operating and maintenance personnel.

1.4 Symbols in these operating instructions

The following symbols are found in this documentation:



Danger!
Hazardous situation which may lead to death or serious injury if the instructions are not followed.



Warning!
Hazardous situation which may lead to death or serious injury if the instructions are not followed.



Caution!
Hazardous situation which may lead to (minor) injuries if the instructions are not followed.



Note:
Information concerning individual procedures, explanations, or tips for simplified approaches. Also indicates situations which may result in material damage.

■ This symbol indicates an "Action Point" and shows that you should carry out an operation/procedure.

1.5 Other applicable documents

The general plant documentation for the room where the equipment is situated (construction specifications for the ventilation system) also applies in conjunction with these assembly and operating instructions.

1.6 Normative instructions

1.6.1 Legal information concerning the operating instructions

We reserve the right to make changes in content. Rittal GmbH & Co. KG is not responsible for any damage which may result from failure to comply with these assembly and operating instructions. The same applies to failure to comply with the valid documentation for accessories used.

1.6.2 Copyright

The distribution and duplication of this document and the disclosure and use of its contents are prohibited unless expressly authorised.

Offenders will be liable for damages. All rights created by a patent grant or registration of a utility model or design are reserved.

1.6.3 Revision

Rev. 2A of 11/29/2019

2 Safety instructions

2

2 Safety instructions

The devices in the LCP DX series produced by Rittal GmbH & Co. KG are developed and produced with due regard for all safety precautions. Nevertheless, the unit still poses a number of unavoidable dangers and residual risks. The safety instructions provide you with an overview of these dangers and the necessary safety precautions.

In the interests of your safety and the safety of others, please read these safety instructions carefully before assembly and commissioning of the LCP DX.

Follow the user information found in these instructions and on the unit carefully.

2.1 Important safety instructions:



Danger! Electric shock!

Contact with live electrical parts may be lethal.

Before switching on, ensure that there is no possibility of accidental contact with live electrical parts.

The unit has a high discharge current. Before connecting to the supply circuit, therefore, it is essential to make a 6 mm² earth connection (see section 16.7 "Circuit diagram").

Please remember that the electronics box is still live even when the master switch is off. Particularly when working on the electronics box, and for all servicing work, the device must be completely disconnected from the power supply.



Danger! Injury caused by fan impellers!

Keep persons and objects away from the fan impellers! Do not remove covers until the power supply is disconnected and impellers are not moving! Always use mechanical protection when working! Shut down the respective fan during maintenance work! Tie long hair back! Do not wear loose clothing! Fans start up automatically following power disruptions!



Danger! Hot components may cause injury!

In particular, never touch the compressor and cables while operational and for some time thereafter, as they may still be hot.



Danger! Risk of poisoning from coolant gases created under the influence of heat.

When carrying out welding and soldering work on the coolant circuit, use protective gloves and breathing apparatus with a filter. In case of major leaks, stop smoking immediately. Avoid fire and naked flames.



Danger! Risk of injury from incorrect installation.

Installation of the coolant lines and other media connections must only be carried out by qualified plumbers or cooling technology specialists.



Danger! Threat to the environment from escaping coolant!

Never allow the coolant to escape into the environment if at all possible (see section 2.3.3 "F-gas regulation").



Danger! Threat to the environment from escaping cooling water!

Never allow the cooling water to escape into the environment if at all possible.



Danger! Injury due to falling loads!

Do not stand under suspended loads when transporting the unit with a hoist trolley, a forklift, or a crane.



Warning! Danger of cut wounds, especially from the sharp edges of the fan module and heat exchanger modules! Put on protective gloves before beginning assembly or cleaning work!



Warning! Injuries from escaping coolant!

Escaping gas may freeze the skin. Before working on the cooling circuit, put on protective gloves and goggles.



Caution! Risk of malfunction or damage!

Do not modify the unit! Use only original spare parts!



Caution! Risk of malfunction or damage!
Proper and flawless unit operation can only be ensured when it is operated under the intended ambient conditions. As far as possible, observe the ambient conditions for which the unit was designed, e.g. temperature, humidity, air purity.



Caution! Risk of malfunction or damage!
All media required for the control system, such as the correct fill volume of coolant, must be available throughout the entire operating period of the device.



Caution! Risk of malfunction or damage!
Installation, and in particular the coolant line pipework between the external condenser and the LCP DX, must only be carried out by trained, qualified and accredited cooling system specialists.



Caution! Risk of malfunction or damage!
In order to prevent EMC-related malfunctions during operation, and to allow access for servicing purposes, cross-wiring through the LCP DX to the bayed racks is prohibited.

As a general requirement, please observe the following five safety rules to DIN EN 50110-1 (VDE 0105-1) when working in and on the LCP DX, in order to avoid accidents:

1. Switch off!
Switch off the LCP DX at the master switch.
2. Prevent reactivation!
3. Ensure that all poles are de-energised!
4. Earth and short-circuit!
5. Cover or shield adjacent, live parts

2.2 Service and technical staff

The installation, commissioning, maintenance and repair of this unit may only be carried out by trained, qualified mechanical and electro-technical personnel.

Only properly instructed personnel may service a unit while in operation.

2.2.1 Personal safety equipment

Personal safety equipment is to be worn during any work on this unit when personnel might come into contact with refrigerant and in general for all maintenance work (see section 16.1 "Coolant information"). As a minimum requirement, personal safety equipment is comprised of the following components:

- thermally insulated gloves
- protective goggles
- in the event of fire, airtight respiratory masks must be worn.

2.3 Operator requirements

In accordance with EU Regulation 517/2014, the operator must carry out a leak test of the coolant circuit using a suitable test device at least once a year. Any leaks that are detected must be repaired immediately.



Note:

Rittal offers leak testing of the device as a service.

2.3.1 Abbreviated instructions

The operator must ensure that abbreviated instructions containing the following information are available in a readily accessible location on the LCP DX.

1. Name, address and telephone number of the installation company, its customer service department, or the customer service department of the owner/operator, or as a minimum requirement, the individual responsible for the cooling system, together with the address and telephone number of the fire brigade, police, hospitals and burn victims centres.
2. Type of refrigerant: R410A, comprising 50% difluoromethane R32 (CH₂F₂) and 50% R125 pentafluoroethane (C₂HF₅);
3. Instructions for switching off the cooling system in an emergency (see section 7.2.3 "Switching off in an emergency");
4. The maximum permissible pressures (see section 11 "Technical specifications").

2.3.2 System log

Under DIN EN 378, the operator is required to keep a system log and ensure that it is regularly updated. The system log should contain the following information:

1. Details of all repair work
2. Quantity and type (new, reused or recycled) of refrigerant added, quantity of refrigerant removed
3. Outcome of any analysis of reused refrigerant, if available
4. Origin of reused refrigerant
5. Amendments to and replacement of system components
6. Results of all regular routine checks and
7. Any significant shutdowns.

2.3.3 F-gas regulation

Regulation (EC) No. 517/2014 of the European Parliament and of the Council of 16 April 2014 on certain fluorinated greenhouse gases entered into force on 9 June 2014. The Regulation regulates the reduction of emissions, the use, recovery and destruction of certain fluorinated greenhouse gases, and the labelling and disposal of products and equipment containing such gases.

2 Safety instructions

2

Leak test pursuant to Article 4 (leak checks)

The leak checks shall be carried out with the following frequency, depending on the CO₂ equivalent quantities of fluorinated greenhouse gases.

- **5 t – 50 t** at 12-month intervals, (or where a leakage detection system is installed, at least every 24 months),
- **50 t – 500 t** at 6-month intervals, (or where a leakage detection system is installed, at least every 12 months),
- **more than 500 t** at 3-month intervals, (or where a leakage detection system is installed, at least every 6 months).

2.3.4 Chemicals – Climate Protection Ordinance

This Ordinance applies in addition to the aforementioned Regulation (EC) No. 517/2014 of the European Parliament and of the Council of 16 April 2014.

2.4 RoHS compliance

The LCP DX fulfils the requirements of EU Directive 2011/65/EC on the Restriction of Use of Certain Hazardous Substances in Electrical and Electronic Equipment (RoHS) of 1 July 2011.



Note:

Corresponding information about the RoHS Directive may be found on our website at www.rittal.com/RoHS.

3 Device description

3.1 General functional description

3.1.1 LCP DX

The Liquid Cooling Package DX (DX = Direct Expansion) is essentially a split air conditioning unit used to dissipate high heat losses from server enclosures or for the effective cooling of devices built into a server enclosure.

The air routing in the LCP DX supports the "front to back" cooling principle of the devices built into the server enclosure. The hot air expelled by the devices in the server enclosure is drawn in by the fans at the rear directly from the hot aisle and thus routed through the heat exchanger module.

In the heat exchanger module, the heated air is directed through a heat exchanger (coolant evaporator), and its thermal energy (heat losses from the server) is transferred to the coolant. This causes the coolant to change from a liquid to a gaseous state. As a result, the air is cooled to a freely selectable temperature within the authorised parameters and then routed into the cold aisle. In its delivered state, cold air is expelled to the front; it is also possible to expel the cold air on both sides, or by mounting a side panel, at one side of the device.

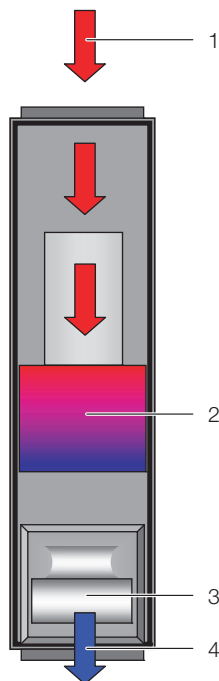

Fig. 1: Air routing – top view

Key

- 1 Air inlet
- 2 Heat exchanger
- 3 Fan module
- 4 Air outlet

The temperature of the impelled cold air is controlled by continuously comparing the actual temperature with the setpoint temperature (preset to +22°C).

If the actual temperature exceeds the setpoint temperature, the speed of the compressor is automatically increased, providing a greater cooling output from the heat exchanger, until the setpoint temperature is reached.

The temperature differential between the setpoint and the warm air intake is used to calculate and control the fan speed.

Any condensate incurred is collected in the condensate collecting tray integrated into the LCP DX below the heat exchanger, and from there is routed outside via a condensate discharge hose.

3.1.2 LCP DX/FC

The Liquid Cooling Package DX/FC (FC = indirect Free Cooling) is essentially also a split air conditioning unit used to dissipate high heat losses from server enclosures or for the effective cooling of devices built into a server enclosure. For the LCP DX/FC, a second, water-based cooling circuit (so-called free cooling circuit) is used in addition to the coolant circuit.

The heating exchanger module is provided in duplicate, with separate modules for the cooling water circuit and the coolant circuit. The heated air is routed through the heat exchanger, first through the water-based part and then through the coolant-based part. The thermal energy in the air (thermal output from the server enclosure) is emitted to the water or coolant in this way. The device decides autonomously, based on the ambient conditions, whether the required cooling output can be achieved with just the water-based cooling circuit, in a mixed mode with both circuits, or just with the coolant-based circuit. The air is cooled to a freely selectable temperature within the authorised parameters and then routed into the cold aisle.

In its delivered state, cold air is expelled to the front, like in the LCP DX; it is also possible to expel the cold air on both sides, or by mounting a side panel, at one side of the device.

The temperature of the impelled cold air is controlled by continuously comparing the actual temperature with the setpoint temperature (preset to +22°C).

If the actual temperature exceeds the setpoint temperature, depending on the ambient conditions, the water throughput and/or the speed of the compressor is automatically increased, providing a greater cooling output from the heat exchanger, until the setpoint temperature is reached.

The temperature differential between the setpoint and the warm air intake is used to calculate and control the fan speed.

Any condensate incurred is collected in the condensate collecting tray integrated below the heat exchanger, like in the LCP DX, and from there is routed outside via a condensate discharge hose.

3 Device description

3.2 Air routing

In order to achieve sufficient cooling in the server enclosure, it is important to ensure that the cooling air passes through the interior of the built-in units and is unable to flow past at the sides.

Targeted air routing by hot air extraction from the hot aisle and cold air blown into the cold aisle has a fundamental effect on the amount of heat to be dissipated.

In order to ensure targeted air routing in the system, the server enclosure should be divided vertically into warm air and cold air sections. The division is accomplished in the front section of the server assembly to the left and right of the 482.6 mm (19") level using foam strips or air baffle plates which, depending on the enclosure width and the number of server enclosures to be cooled, can be ordered as an accessory (see section 13 "Accessories").

If devices which require sideways air throughput are also built into the server enclosure (e.g. switches, router, etc.), these may be cooled by means of targeted placement of the foam strips or air baffle plates.

Note:



The 482.6 mm (19") level must likewise be completely sealed. This is already the case in a fully equipped server enclosure. With a partially configured server enclosure, the open height units (U) of the 482.6 mm (19") level must be sealed with blanking plates, which are available as Rittal accessories (see section 13 "Accessories").

The more devices are installed in the server enclosure, the more important it becomes to follow this specification.

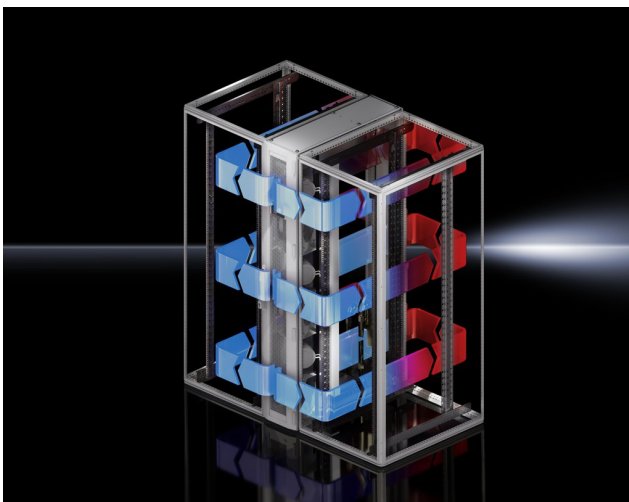

Fig. 2: LCP DX on two server enclosures

Additionally, the system consisting of LCP DX, server enclosure and cold aisle containment should be well sealed in order to avoid a decrease of the cooling capacity due to mixing of cold and hot air. This is achieved by sealing the cold aisle with doors at the beginning and

end of the rack rows, and sealing it at the top with roof elements. Existing cable entry glands are additionally sealed e.g. using suitable brush strips.

3.3 Equipment assembly

3.3.1 Unit components

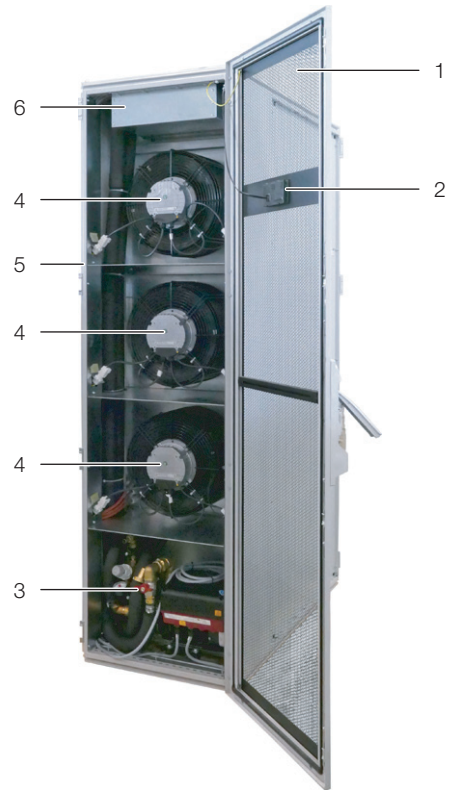

Fig. 3: LCP DX/FC front – open front door

Key

- 1 LCP door
- 2 Display
- 3 Water unit (LCP DX/FC version only)
- 4 Fan (3 x)
- 5 Rack
- 6 Additional electronics box for options

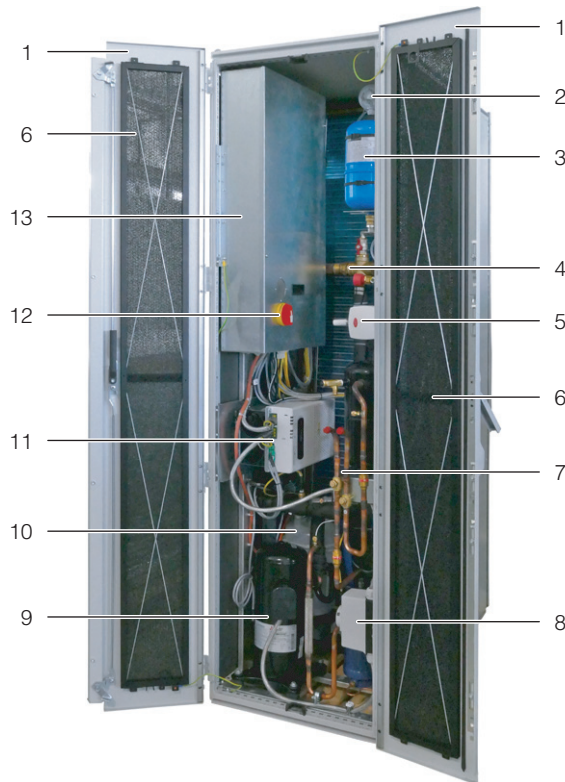

Fig. 4: LCP DX/FC rear – rear door open

Key

- 1 Rear doors
- 2 Differential pressure sensor (option "air filter")
- 3 Expansion tank (LCU DX/FC version only)
- 4 Water unit pipework (LCP DX/FC version only)
- 5 Humidity sensor (option "humidifier" and "dehumidification")
- 6 Air filter (option "air filter")
- 7 Connection lines to the external condenser
- 8 "Compressor" maintenance switch
- 9 Compressor
- 10 Humidifier (option "humidifier")
- 11 Inverter
- 12 Main switch
- 13 Electronics box with voltage connection and network connection

3.3.2 Coolant circuit

The coolant circuit consists of the following components:

- Compressor: The compressor compresses the coolant and causes it to circulate from the low-pressure side (evaporator coil) to the high-pressure side (external condenser). The motor is activated by an external inverter, which controls the speed of the compressor and therefore allows the cooling output to be precisely adapted to the actual cooling requirement.
- Evaporator coil: The evaporator coil (air/coolant heat exchanger) is positioned in the centre of the LCP DX. In the LCP DX/FC, the heating exchanger module is provided in duplicate, with separate modules for the cooling water circuit and the coolant circuit. Any condensate incurred is discharged into a condensate collecting tray in the bottom section of the device.

- Electronic expansion valve: The expansion valve supplies the evaporator coil with the required volume of coolant to provide the corresponding cooling output in the current ambient conditions.
- External condenser: The condenser is sited outdoors from the room where the LCP DX is situated. In the LCP DX/FC, the external condenser is also provided in duplicate, with separate modules for the cooling water circuit and the coolant circuit. Connection details for the LCP DX may be found in section 6 "Installation".
- Temperature sensors: There are two temperature sensors installed on the front of the device near the fans. These measure the cold air temperature and forward the readings to the control unit. There are two further temperature sensors installed on the rear of the evaporator coil. These measure the hot air temperature and likewise forward the readings to the control unit.

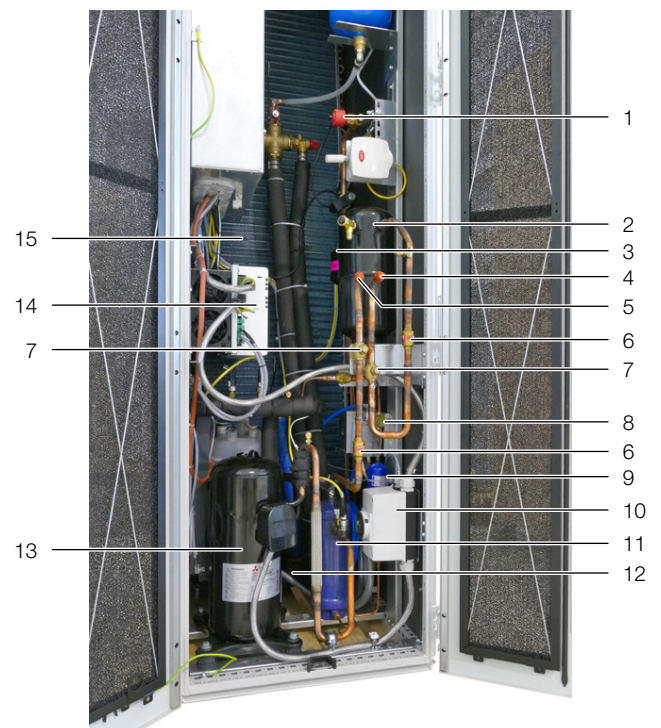

Fig. 5: Coolant circuit – rear of the unit

Key

- 1 Electronic expansion valve
- 2 Refrigerant collector
- 3 Filter dryer
- 4 Liquid line
- 5 Hot gas line
- 6 Non-return valve
- 7 Manual shut-off valves liquid line and hot gas line
- 8 Oil filter
- 9 Sight glass refrigerant
- 10 "Compressor" maintenance switch
- 11 Oil separator
- 12 Condensate collecting tray
- 13 Compressor
- 14 Inverter
- 15 Evaporator coil

3 Device description

3.3.3 Water circuit (LCP DX/FC only)

In the LCP DX/FC, a water cooling circuit is integrated in addition to the coolant circuit. The unit is operated with an external condenser for indirect free cooling. Hence, in the appropriate ambient conditions, cooling of the hot air occurs either with the water-based cooling circuit only, in a mixed mode with both circuits, or with the coolant-based circuit only.



Fig. 6: Water circuit – at the front bottom of the device

Key

- 1 Electrical connection for condenser, for indirect free cooling
- 2 Pump
- 3 Cooling water inlet (where connected to the top of the device)
- 4 Cooling water return (where connected to the top of the device)
- 5 Manometer
- 6 Pressure regulating valve
- 7 Shut-off valve
- 8 Connection for filling

On the rear of the LCP DX/FC, there is also an expansion tank for the water circuit (fig. 4, item 3) and the relevant pipework (fig. 4, item 4).

3.3.4 External condenser

An external condenser is required in order to operate the device. Only Rittal-supplied condenser units may be used. The following options are available:

- Model No. 3311.370: Standard condenser for use with an LCP DX (cooling circuit only)
- Model No. 3311.380: Condenser for indirect free cooling for use with an LCP DX/FC (coolant and water circuit)
- Model No. 3311.XXX: High-temperature condenser for use with an LCP DX (coolant circuit only) at high external temperatures

3.3.5 Fan module



Fig. 7: Fan module

Key

- 1 Assembly screws (4 x)
- 2 DC connection cable (control voltage)
- 3 AC connection cable (power supply)
- 4 Fan
- 5 Air baffle plate

A fan module is essentially comprised of the fan itself. All three fan modules are controlled via a joint control unit. Fans may be operated with linear control between 30% and 100%.

The fan modules are installed on rack-mounted shelves in the front section of the LCP DX.

It takes approximately 2 minutes to replace a single fan module with the system operational (see section 9.3 "Fan replacement").

3.4 Proper and improper usage

The LCP DX is used to dissipate high heat losses and effectively cool devices built into a server enclosure. The unit is designed solely for static use in sealed rooms.

The unit is state of the art and built according to recognised safety regulations. Nevertheless, improper use can present a hazard to life and limb of the user or third parties, or result in possible damage to the system and other property.

Consequently, the unit must only be used properly and in a technically sound condition.

Any malfunctions which impair safety should be rectified immediately. Follow the operating instructions!

Proper usage also includes following the operating instructions and fulfilling the inspection and maintenance conditions.

Inappropriate use can be dangerous. Examples of inappropriate use include:

- Using in an environment that does not generate an adequate heat load, for example, due to insufficient installed equipment.
- Using a different condenser unit not supplied by Rittal.
- Use of impermissible tools.
- Improper operation.
- Use of a coolant other than R410A.
- Use of a coolant fill volume other than that specified.
- Using with insufficient or excessive cooling water fill levels (LCP DX/FC only).
- Installation of the external condenser in an unsuitable position.
- Operation with less than three installed fans.
- Improper rectification of malfunctions.
- Use of replacement parts which are not authorised by Rittal GmbH & Co. KG.
- Non-static use, e.g. on moving or vibrating machines.

3.5 Supply scope of a LCP DX

The LCP DX supply includes:

Qty.	Parts
1	LCP DX, ready for connection
	Accessories:
1	Condensate hose
1	Sealing strip

Tab. 1: Supply scope of a LCP DX

4 Transportation and handling

4 Transportation and handling

4.1 Transportation

The LCP DX is delivered shrink-wrapped on a pallet.



Caution!

Because of its height and small base, the LCP DX is subject to tipping. Risk of toppling, especially after the unit is removed from the pallet!



Caution!

Transport of the LCP DX without a pallet: Use only suitable and technically sound lifting gear and load-bearing devices with sufficient load capacity.

4.2 Unpacking

- Remove the unit's packaging materials.



Note:

After unpacking, the packaging materials must be disposed of in an environmentally friendly way. They are comprised of the following materials:

Wood, polyethylene film (PE film), strap, edge protectors.

- Check the unit for any damage that occurred during transport.



Note:

Damage and other faults, e.g. incomplete delivery, should immediately be reported to the shipping company and to Rittal GmbH & Co. KG in writing.

- Place the unit in its intended location.

5 Assembly and siting

5.1 General

5.1.1 Installation site requirements

In order to ensure problem-free operation of the LCP DX, the following conditions for the installation site should be observed:

Positioning of the LCP DX in the server room relative to the external condenser

The interior device (LCP DX) and the external condenser must be connected with a suitable copper pipe connection in accordance with DIN EN 378-2. The entire system must then be filled with coolant (see section 6.2.2 "Notes on pipework").

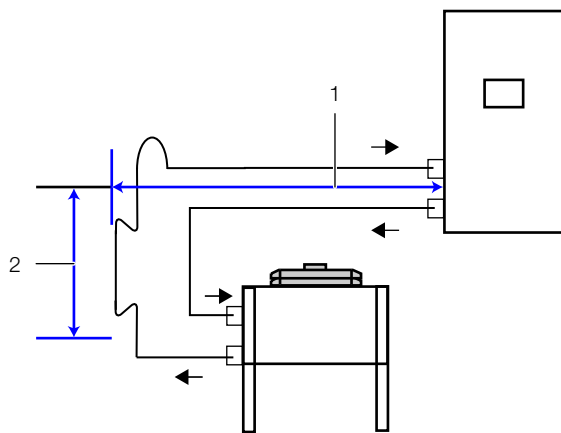

Fig. 8: Relative positioning condenser below the LCP DX

Key

- 1 Offset in a side direction
- 2 Condenser offset below the LCP DX

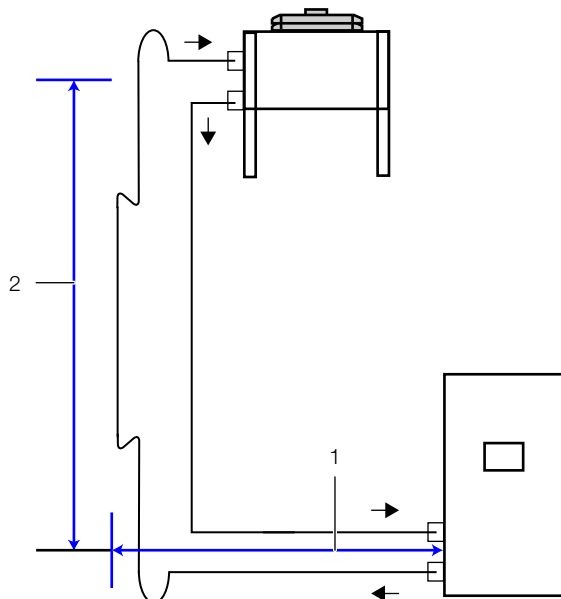

Fig. 9: Relative positioning above the LCP DX

Key

- 1 Offset in a side direction
- 2 Condenser offset above the LCP DX

The following distances and geodetic height differences must not be exceeded when installing the LCP DX and the external condenser:

Position	Distance
Sum total of horizontal (fig. 8, item 1) and vertical spacing (fig. 8, item 2 or fig. 9, item 2) between the LCP DX and the condenser	Max. 60 m equivalent length
Condenser above LCP DX (fig. 9, item 2)	max. 20 m
Condenser below LCP DX (fig. 8, item 2)	max. 3 m

Tab. 2: Distances and height differences



Note:

When calculating the equivalent length, please also refer to section 6.2.2 "Notes on pipework".

For the LCP DX/FC, a suitable connection from the water circuit to the condenser for indirect free cooling must be provided.

Supply connections required at the installation site

Type of connection	Connection description:
LCP DX power inlet standard version	380...480 V ±10 %, 3~, N, PE, 50/60 Hz
External condenser 3311.370 power inlet	230 V, 1~, 50/60 Hz
External high temperature condenser 3311.XXX power inlet	230 V, 1~, 50/60 Hz
Power connection to condenser for indirect free cooling 3311.380	Connection is made directly to the LCP DX/FC

Tab. 3: Supply connections required at the installation site

5 Assembly and siting

5

Type of connection	Connection description:
External diameter of coolant lines	Copper pipework 1 mm wall thickness – equivalent length up to 10 m (LCP DX to outdoor unit): $\varnothing_a=16$ mm (hot gas line)/ 16 mm (liquid line) – equivalent length from 10 m to 30 m (LCP DX to outdoor unit): $\varnothing_a=18$ mm (hot gas line)/ 16 mm (liquid line) – equivalent length from 30 m to 45 m (LCP DX to outdoor unit): $\varnothing_a=22$ mm (hot gas line)/ 16 mm (liquid line) – equivalent length from 45 m to 60 m (LCP DX to outdoor unit): $\varnothing_a=22$ mm (hot gas line)/ 18 mm (liquid line)
Connection of cooling water lines (LCP DX/ FC only)	2 x 1½" pipe thread connection (internal thread) or 2 x hose connections (grommet)

Tab. 3: Supply connections required at the installation site



Note:

A voltage of at least 380 V is required to start the device.
 If the mains voltage briefly drops 10% below 380 V with the system operational, it will not malfunction.



Note:

Please also observe the instructions and data relating to the coolant connection as outlined in section 6 "Installation".



Recommendation:

For easier servicing of the LCP DX, maintain a distance of at least 1 m between the front and rear of the device and the nearest wall.

Floor conditions

- The floor of the installation space should be rigid and level.
- Choose the installation site so that the unit is not situated on a step or uneven surface, etc.

Climatic Conditions



Recommendation:

Room temperature +22°C at 50% relative air humidity, according to ASHRAE guidelines. Where necessary, these values should be achieved by an additional room air-conditioning system.

Electromagnetic interference

- Interfering electrical installations (high frequency) should be avoided.

Heat loss from the equipment

- The equipment in the server enclosure being cooled must generate a heat loss of at least 7 kW.

5.1.2 Prepare the installation room

The installation room must be divided into one cold air zone and one hot air zone. This ensures that no cooling capacity is lost due to mixing of cold and hot air.

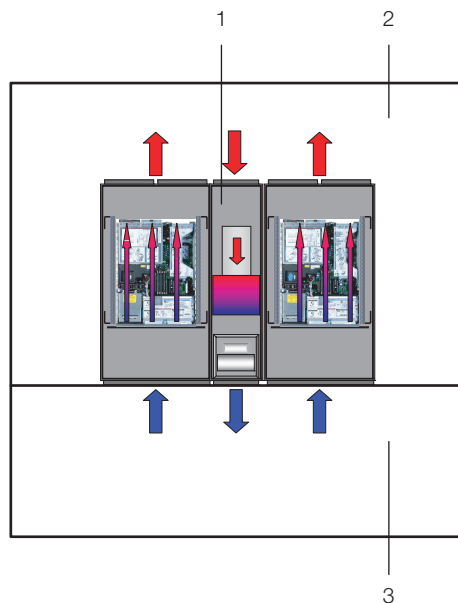

Fig. 10: Installation room with cold aisle containment

Key

- 1 LCP DX
- 2 Hot aisle
- 3 Cold aisle



Note:

All the components needed for cold aisle containment are available from Rittal as accessories.

5.1.3 Installation guidelines

The positioning in the rack aisles must be considered when planning the layout. The following points are to be considered:

- Heat loss in the adjacent server racks

- Air throughput in the adjacent server racks
- Distances from the adjacent server racks

Heat losses in the adjacent server racks

If the LCP DX is used in combination with server enclosures with high heat losses, the number of LCP DX units must be adapted according to the characteristic curves. The air temperature difference between server inlet and server outlet, which is determined by the equipment used, is particularly important. As a rule of thumb, a temperature difference of 15 K can be expected. There may, however, be greater differences.

Air throughput in the adjacent server racks

Due to the containment of the hot and cold zones, it is important to ensure that the LCP DX delivers a sufficient amount of cold air into the cold zone. From there, the cold air is drawn back into the server enclosures by the equipment. A small surplus of air should generally be provided in order to compensate for any short-term demands of the equipment.

Distances from the adjacent server racks

In small applications and short aisles, the above points will not have a major impact on properties or cooling capacity provided the hot zone is thoroughly and precisely sealed off from the cold zone. For larger applications and long aisles, however, it is important to ensure even spacing of the cooling units, due to the loss of air throughput caused by external pressure losses and convection or radiation heat of the equipment. Other factors, such as high-temperature rooms adjacent to the cold zone or exterior walls warmed by the sun, can also occur.

5.2 Assembly procedure

5.2.1 General

Before the LCP DX can be bayed onto a server enclosure, the following work should be carried out.

- Dismantle the side panels,
- Seal the server enclosure and
- Dismantle the server enclosure door.

5.2.2 Fit the attenuators

If applicable, attenuators may be fitted underneath the unit for vibration insulation. For this purpose, the entire LCP DX must be lifted up.



Danger! Injury due to falling loads!
Do not stand under suspended loads when transporting the unit with a hoist trolley, a forklift, or a crane.



Caution! Risk of injury!
Attenuators must only be attached to the LCP DX by suitably trained experts.

- Lift up the LCP DX using appropriate lifting gear with an adequate load capacity.
- Attach the attenuators underneath the unit.
- Slowly and carefully lower the LCP DX onto the attenuators.

5.2.3 Dismantle the side panels



Caution! Risk of injury!

The side panel holders have sharp-edged teeth, which enable earthing of the server enclosure's side panel.

If there is a side panel or partition mounted on the server enclosure side to which the LCP DX is to be bayed, this must be removed first.

- Loosen and remove the 8 assembly screws found on each side panel of the server enclosure.
- Remove all side panel securing elements from the side of the server enclosure onto which the LCP DX is to be bayed.
- Dismantle both side panel mountings from the upper mounting rail of the server enclosure, using an appropriate lever.
- Loosen and remove the screws on both of the side panel mounting brackets (top and bottom) in the middle of the mounting rail.
- Loosen and remove the screws from the 6 side panel holders on the side mounting rails.

5.2.4 Seal the server enclosure

In order to ensure targeted air routing in the system, the server enclosure is vertically divided into hot air and cold air zones by sealing the 482.6 mm (19") level.

Proceed as follows to seal the 482.6 mm (19") level:

- If the server enclosure is only partially configured, seal the open sections of the 482.6 mm (19") level using blanking plates. Screw these tightly into the server rack from the front.



Note:

Blanking plates in a range of height units (U), together with both narrow and wide foam strips and air baffle plates, are available as Rittal accessories (see section 13 "Accessories").

- Fasten the wider (Model No. 3301.370 / 3301.320) of the two foam strips from the LCP DX accessories onto one of the front uprights of the server rack from the outside (fig. 11). Make sure to install this strip on the side of the server enclosure onto which the LCP DX is to be bayed.
- If you are only baying the LCP DX on one side: Fasten the narrower (Model No. 3301.380 / 3301.390) of the two foam strips from the LCP DX accessories onto one of the front uprights of the server rack from the outside (fig. 11). Make sure to install this strip on

5 Assembly and siting

the side of the server enclosure which will again be sealed by a side panel.

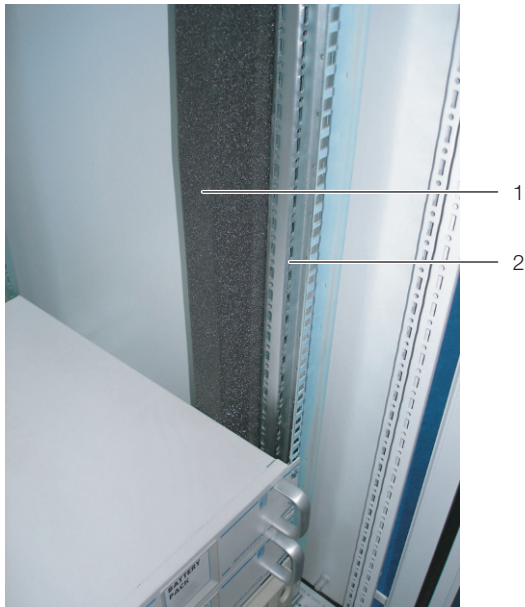

Fig. 11: Foam strip on a server rack upright

Key

- 1 Foam strip
- 2 Server rack

If the server enclosure contains devices which require cooling via sideways air throughput (e.g. switches, router, etc.), cut-outs must be incorporated into the foam strips.

- To do this, cut out a piece of the foam strip using a sharp knife.
- If several devices which require sideways air throughput are included, cut out several pieces of the foam strip, as is appropriate, so that, ultimately, there is a cut-out in the foam to the left or right at the height of each such device in the server rack. Ensure that there are no gaps on the hot air side of the devices (fig. 12, item 3).
- Using a sharp knife, cut additional pieces from the foam strip that are at least as long as the height of the built-in devices.
- Attach the foam strips to the cold air side of the devices set back towards the rear (fig. 12, item 5), making sure that all fans built into the devices can draw air and that none of them are blocked.



Note:

The foam strips can be attached between the front and rear uprights of the server rack along the entire depth of the devices with sideways air throughput (fig. 12, item 1).

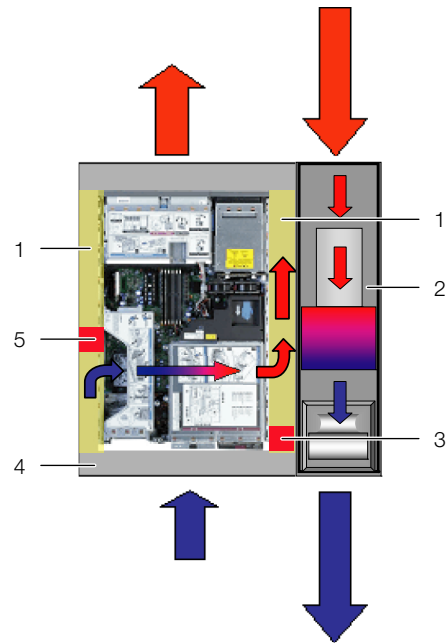

Fig. 12: Placement of foam strips for devices with sideways air throughput (top view)

Key

- 1 Area in which the foam strips can be positioned
- 2 LCP DX
- 3 Foam strips on hot air side
- 4 Server enclosure
- 5 Foam strips on cold air side

- If there is any surplus length of the foam strip on the server rack, cut it off at the top edge of the rack.



Note:

The LCP DX may optionally be bayed onto a server enclosure either 600 mm or 800 mm wide. For this reason, the LCP DX accessories include a total of four foam strips or corresponding air baffle plates with differing dimensions (see section 13 "Accessories").

- On the side of the server enclosure opposite the LCP DX, mount a side panel on the two side panel mountings. Align it with the front and rear of the enclosure.
- Using the 8 assembly screws, screw the side panel firmly onto the side panel holders and the side panel mounting brackets.
- Seal off any cable entries which may be present with corresponding brush strips or similar.

5.2.5 Dismantle the server enclosure door

Before baying a LCP DX, at least one of the two server enclosure doors must be dismantled so that the attachment points for the baying connectors are accessible and are not covered by a door edge.



Note:

It is only necessary to dismantle a server enclosure door when the LCP DX is to be bayed onto a previously erected server enclosure. Otherwise, this work is not necessary. If the LCP DX is to be installed together with a new server enclosure, proceed according to the enclosure's assembly instructions and bay the LCP DX onto the server enclosure before assembling the server enclosure doors.

Proceed as follows to dismantle a server enclosure door:

- Remove the sealing bungs from the four door hinges using an appropriate tool (e.g. screwdriver).
- Release and open the server enclosure door.
- Loosen the hinge bolts from the four door hinges by raising them with an appropriate tool (e.g. screwdriver). Pull the bolts out of the hinge pin holding fixture as far as they will go (see fig. 13, step A). Begin with the lowest door hinge.

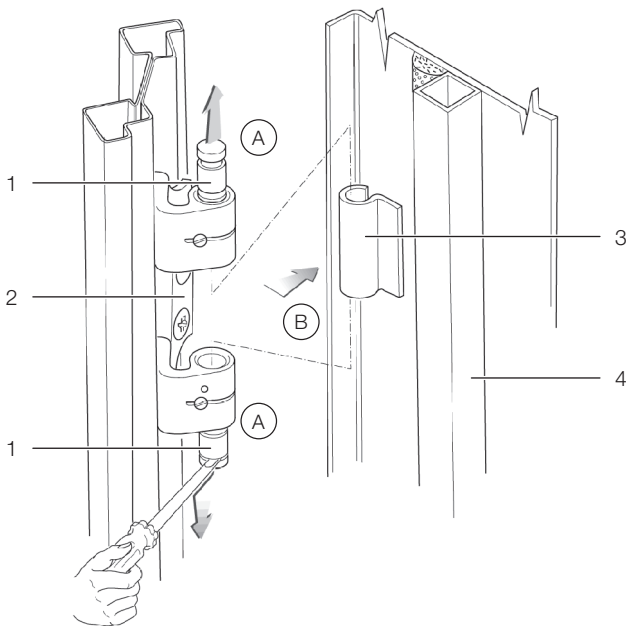

Fig. 13: Removing a door hinge

Key

- 1 Door hinge
- 2 Hinge pin holding fixture
- 3 Hinge joint
- 4 Server enclosure door



Note:

Support the server enclosure door so that it will not fall as the door hinge pins are loosened. If necessary, work with a second person.

- Remove the server enclosure door (fig. 13, step B).

5.2.6 Installation and baying of the LCP DX

- Position the LCP DX on the side of the server enclosure to which it is to be bayed.
- Align the LCP DX with the server enclosure. Ensure that the LCP DX is aligned horizontally and that both enclosures are adjusted to the same height and are vertically aligned to each other.

Attaching with baying connectors

- Dismantle the door of the LCP DX whose hinges are on the side on which the server enclosure is to be bayed. Proceed as described in section 5.2.5 "Dismantle the server enclosure door".



Note:

If the LCP DX is to be bayed between two server enclosures, all doors of the LCP DX must be dismantled before the baying connectors are installed, so that the attachment points for the baying connectors are accessible.

- Using the corresponding assembly screws, fasten three baying connectors each (fig.14, item 2) onto the attachment points provided in the mounting strips on the front and rear of the LCP DX (fig.14, item 1).

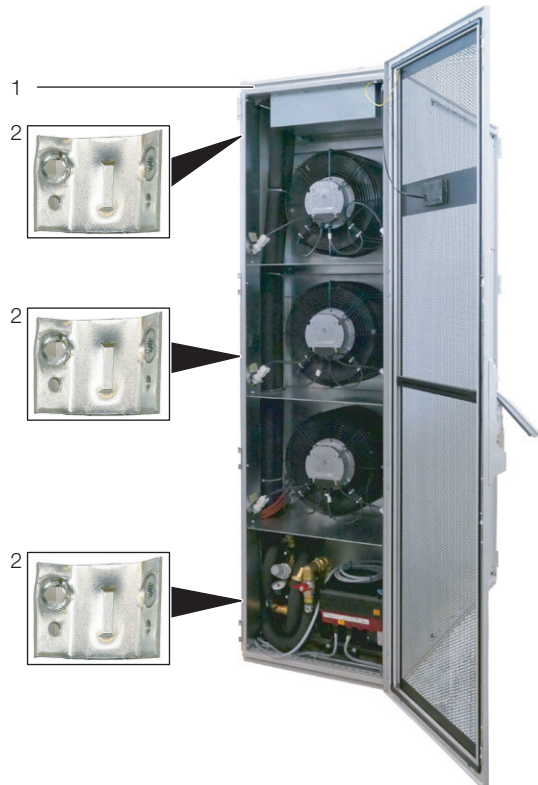

Fig. 14: Rear

Key

- 1 LCP DX
- 2 Baying connector

- In the same way, fasten the baying connectors onto the attachment points provided in the mounting strips

5 Assembly and siting

5

on the front and rear of the server enclosure. As needed, press the LCP DX lightly against the server enclosure in order to bring the baying connectors into alignment with the attachment points.

- Attach all doors to the LCP DX again.
- Finally, check the stability of the LCP DX once again.

Attaching with baying clamps

- In the front section, push out a baying clamp (fig. 15, item 3) from the server enclosure (fig. 15, item 2) through the corresponding notch in the side panel of the LCP DX (fig. 15, item 1).
- From the server enclosure, tighten the baying clamp (fig. 15, item 4), so that the frames of the server enclosure and LCP DX are firmly connected to one another.

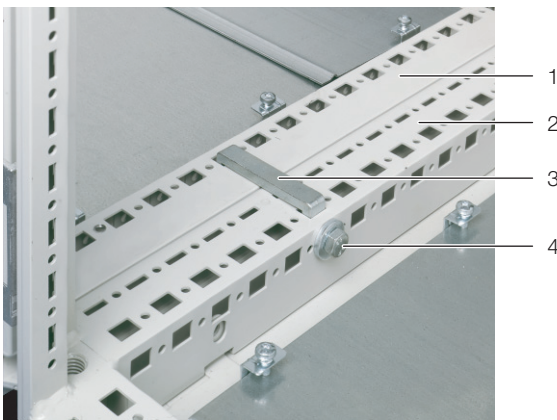

Fig. 15: Baying clamp

Key

- 1 LCP DX
- 2 Server enclosure
- 3 Baying clamp
- 4 Assembly screw of baying clamp

- In the same way, insert a second baying clamp to connect the server enclosure and LCP DX in the rear section.

5.2.7 Mounting the side panel

If the LCP DX is not bayed between two server enclosures, close it off with a side panel.



Caution! Risk of injury!

The side panel holders have sharp-edged teeth, to enable earthing of the side panel through the LCP DX.

Proceed as follows to assemble the side panel:

- Remove the various assembly components from the optional side panel package (Model. No. 8100.235) or use those from a server enclosure which has already been dismantled.
- Using the assembly screws, mount the assembly components (2 side panel mountings, 2 side panel mounting brackets, 6 side panel holders) onto the side

of the LCP DX which is opposite to the server enclosure.

- Place both side panel mountings as symmetrically as possible onto the upper mounting rail of the LCP DX and, using your hand, press them firmly in place.
- Screw down the two side panel mounting brackets top and bottom in the centre of the mounting rail using one screw each.
- Screw down 3 side panel holders onto each of the two side mounting rails with one screw each.
- Mount a side panel onto the two side panel mountings of the LCP DX and align them to the front and rear of the unit.
- Using the 8 assembly screws, screw the side panel firmly onto the side panel holders and the side panel mounting brackets.

5.3 External condenser



Note:

The following instructions on siting the external condenser apply equally to all condenser types available at Rittal.



Note:

If a vent valve is installed on the condenser for indirect free cooling (see section 6.3.2 "Notes on pipework"), the condenser must be positioned in such a way as to allow direct, easy access to the vent valve for maintenance/adjustment purposes.

The installation site of the external condenser must be selected in such a way as to ensure an adequate supply and distribution of the airflow, even in unfavourable conditions (see section 5.1.1 "Installation site requirements").

To ensure ease of access to the external condenser for servicing purposes, a sufficiently large distance from the surrounding walls must be ensured.

It is also important to ensure that no foreign bodies such as leaves can be drawn into the condenser.

With unprotected siting of the external condenser, it is important to prevent unwanted external air streams through the condenser (e.g. via console installation). Such air streams and other weather factors may alter the control response of the LCP DX.

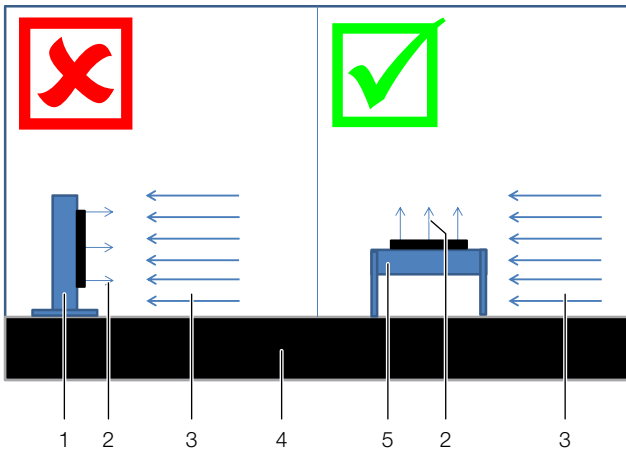

Fig. 16: Air streams with unprotected siting

Key

- 1 Facade mounting
- 2 Condenser airflow
- 3 External air stream
- 4 Building roof or site floor
- 5 Console installation

The condenser is weather-resistant and may therefore be installed completely in the open air, with no need for a weather protection canopy etc. If the condenser is installed underneath a canopy, there must be a distance of at least 4 m between the floor and the canopy.

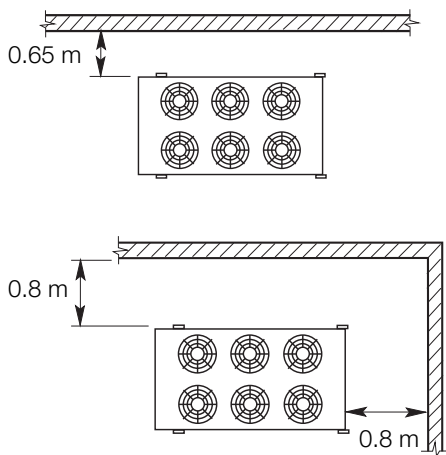

Fig. 17: Minimum distances with vertical mounting.

If the distance is less than 4 m, the condenser must be mounted in such a way that the air outlet is horizontal.

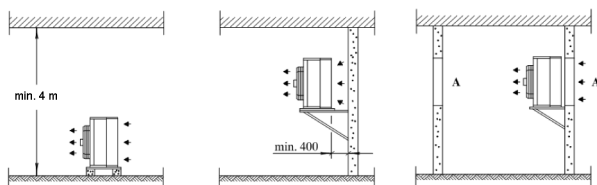

Fig. 18: Installation options with horizontal air outlet



Note:
Opening "A" must be at least as large as the front of the condenser.

The condenser may be installed either horizontally or vertically using the supports included with the supply of the device.

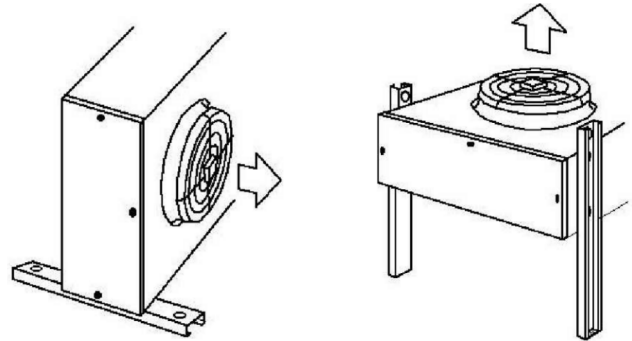

Fig. 19: Horizontal or vertical mounting

In the case of vertical mounting (with a horizontal air-flow), the hot gas line must be laid above the liquid line.

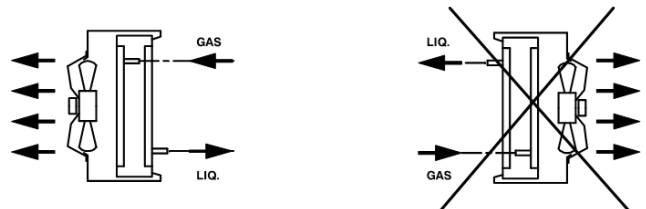

Fig. 20: Laying the hot gas and liquid lines

6 Installation

6 Installation



Caution! Risk of malfunction or damage! Installation, and in particular the coolant line pipework between the external condenser and the LCP DX, must only be carried out by trained, qualified and accredited cooling system specialists.

6.1 General

The interior device LCP DX and the external condenser must be connected with suitable copper pipework. This pipework may either be inserted from above or, if the device is positioned on a raised floor or on a pedestal, from below into the LCP DX.

Additionally, the internal LCP DX/FC unit must be connected to the condenser for indirect free cooling for the cooling water circuit using suitable pipework made from copper, steel, carbon steel and plastic. This pipework can likewise be fitted from below, or optionally from above. Furthermore, an electrical connection (both power supply and control/signal cables) must be provided between the LCP DX/FC and the condenser for indirect free cooling.

Connection diameter LCP DX 35 kW: 16 mm/16 mm

Type of condenser	Connection diameter condenser liquid line/hot gas line [mm]	Equivalent length	External diameter of coolant lines liquid line/hot gas line [mm]
Standard	28/28	Up to 10 m	16/16
		10 m to 30 m	16/18
		30 m to 45 m	16/22
		45 m to 60 m	18/22
High temperature	28/28	Up to 10 m	16/16
		10 m to 30 m	16/18
		30 m to 45 m	16/22
		45 m to 60 m	18/22
Hybrid DX Free cooling	28/35 2"/2"	Up to 10 m	16/16 – 1½/1½
		10 m to 30 m	16/18 – 1½/1½
		30 m to 45 m	16/22 – 1½/1½
		45 m to 60 m	18/22 – 1½/1½

Tab. 4: Refrigerant pipes

General

1. The piping system may be made exclusively of special copper pipes that have been cleansed inside and sealed on both ends. The material of the copper pipework must comply with the specifications outlined in EN 12735-1 / EN 12735-2 and DIN 8964-3.

6.2 Coolant circuit

6.2.1 General

Prior to delivery, the coolant circuit is filled with 1.5 bar nitrogen. It is therefore crucial that the following steps are always carried out in the order shown.



Note:

Installation of the pipework, creation of a vacuum and filling with coolant must only be carried out by qualified, trained staff in accordance with the valid technical regulations.

Furthermore, when carrying out the installation, it is important to observe all the pipework instructions in section 6.2.2.

6.2.2 Notes on pipework

The following basic rules should be observed when connecting the LCP DX and external condenser.

2. The external diameter of the copper pipe must have the dimensions specified in the technical data, both for the hot gas line from the compressor to the condenser, and for the liquid line from the condenser to the expansion valve (see section 11 "Technical specifications"). The copper pipe must be suitable

for the therein stated admissible pressure PS of the R410A coolant, see DIN EN 14276-2.

In order to ensure the correct spatial arrangement of the pipework, particular consideration should be given to the position of the individual pipes, the flow conditions (two-phase flow, oil transportation in part-load operation), condensation processes, thermal expansion, vibration, and good accessibility.

 **Note:**
The routing and brackets of the pipework have a significant influence on the operational reliability and service-friendliness of a cooling system.

As a general rule, pipelines should be laid in such a way as to prevent damage associated with routine activities. For safety reasons, and in order to protect the environment, the following aspects should be taken into account when laying pipework:

1. There must not be any threat to human safety, i.e. escape and emergency vehicle routes must not be obstructed or restricted in any way. When using refrigerants of groups A2, B1, B2, A3 or B3, no detachable connections or fittings must be positioned in publicly accessible areas. When using other refrigerants, protection against unintentional actuation or disconnection should be provided.
2. Pipework should be protected from the thermal influence of hot lines and heat sources by means of spatial separation.
3. Soldering, welding and mechanical joints in connection pipes (e.g. in split systems) should be carried out before the fittings are opened, so as to ensure the flow of refrigerant between the plant parts. A valve should be provided to extract air from the connection pipes and/or any part of the cooling system that remains unfilled.
4. Refrigerant lines must be protected or covered to prevent damage.
5. Flexible connecting parts such as connection lines between indoor and outdoor devices that could become displaced during regular work operations must be protected against mechanical damage.
6. The maximum distance between the brackets of the copper pipes is 2 m.

Laying the pipework

1. The equivalent length of the overall line between the LCP DX and the condenser must not exceed a maximum of 60 m. To calculate the equivalent length, in addition to the actual length of the pipeline, the equivalent length of curves and valves should be taken into account.

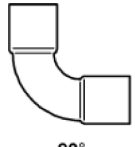
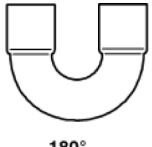
		
45°	90°	180°
0.25 m	0.5 m	0.8 m

Tab. 5: Equivalent length for external diameter 16 mm

2. The number of curves should be kept to a bare minimum so as to avoid pressure losses. Where curves are unavoidable, the radius chosen should be as large as possible.
3. When planning the piping layout ensure that the lines between the LCP DX and the condenser are as short as possible. Only allow for exceptions to save unnecessary bends.
4. If at all possible, do not conduct refrigerant lines through rooms which are occupied by people, such as offices and meeting rooms.
5. The gas line must be laid with an incline of 1% in the direction of flow of the coolant.
6. A distance of at least 20 mm between the gas and the liquid line should be observed. If this is not possible, both lines should be adequately insulated.
7. When laying out the refrigerant lines, be sure no sag is created in which oil may collect; install oil traps if necessary.
8. Provide one elevation arc at least every 6 m of line length.

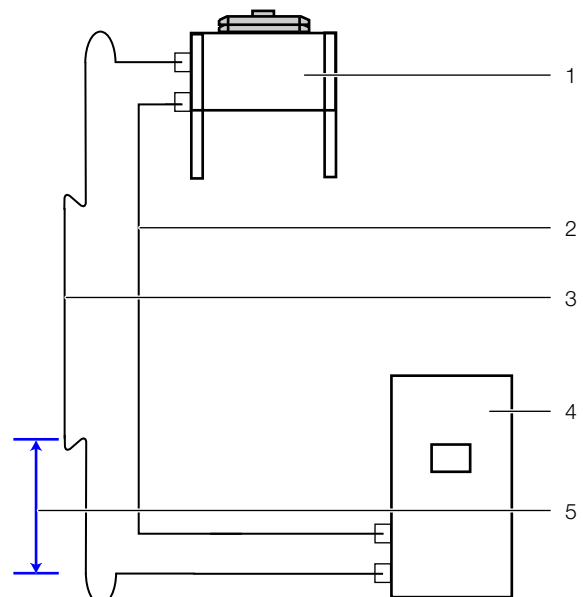

Fig. 21: Oil elevation arc

Key

- 1 External condenser
- 2 Liquid line
- 3 Hot gas line
- 4 LCP DX
- 5 Spacing max. 6 m

6 Installation

Sample calculation of overall length

Calculating the overall length of the pipeline is explained using the following diagram.

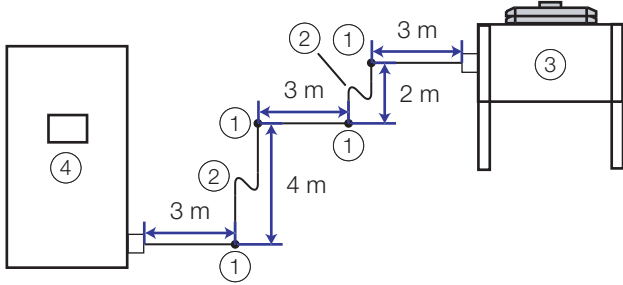

Fig. 22: Simplified representation of connection lines

Key

- 1 Curves 90° (4 x)
- 2 Oil elevation arc (2 x)
- 3 External condenser
- 4 LCP DX

The **overall length** of the pipeline is comprised of the **actual** length of the pipeline and the **equivalent** length of the installed moulded parts. The equivalent length makes allowance for pressure loss from moulded parts such as curves and valves. The overall length calculated in this way must not exceed the maximum admissible length of the pipeline.

The actual length of the pipeline is derived by adding together the line sections (see fig. 22):

$$3\text{ m} + 2\text{ m} + 3\text{ m} + 4\text{ m} + 3\text{ m} = 15\text{ m}$$

The equivalent length is calculated from the built-in moulded parts and the relevant values from table 5:

- 90° curve: Equivalent length "0.5 m"
- Oil elevation arc: Equivalent length "3.0 m"

In this example, there are four 90° curves and two oil elevation arcs installed. This produces the following equivalent length for all moulded parts:

$$4 \times 0,5\text{ m} + 2 \times 3,0\text{ m} = 8,0\text{ m}$$

The overall length is obtained by adding together the actual length and the equivalent length.

$$15,0\text{ m} + 8,0\text{ m} = 23,0\text{ m}$$

In this example, therefore, the calculated overall length is less than the maximum admissible pipeline length, and the installation can therefore be carried out in this form.

Sample calculation of coolant quantity

Only the **actual** length of the pipeline is included in the calculation of required coolant quantity. The number and type of installed moulded parts has **no** influence on the quantity of coolant.

The quantity of coolant for the entire system, including 5.0 pipeline length, is 8.0 kg. 0.1 kg of coolant must be added for each additional metre of pipeline above and beyond the 5.0 m already taken into account. Based on the above example, this therefore produces the following calculation.

- Actual pipeline length 15.0 m
- Additional pipeline length to be taken into account: 15.0 m - 5.0 m = 10.0 m
- Additional quantity of coolant for 10.0 m: 10 x 0.1 kg = 1.0 kg
- Quantity of coolant for 15.0 m: 8.0 kg + 1.0 kg = 9.0 kg

Protecting the pipework

1. Suitable precautions should be taken to prevent excessive vibrations or pulsations. In particular, care should be taken to prevent the direct transmission of noise or vibrations onto or through the supporting structure and the connected devices.



Note:

Vibrations and pulsations should be assessed with the system operational at maximum condensation temperature and when switching the system on and off, which has unfavourable impacts on the pipework.

2. Safety devices, pipework and fittings should be protected from unfavourable environmental influences as far as possible. Due consideration should be given to unfavourable environmental influences, such as the risk of water collecting, freezing of relief lines or the accumulation of dirt and waste.
3. With long pipelines, adequate precautions should be taken with regard to expansion and contraction.
4. The pipelines of cooling systems should be designed and laid in such a way that the system cannot be damaged by liquid slugging (hydraulic shock).
5. Pipelines with detachable connections must not be positioned in public thoroughfares, vestibules, stairwells, steps, entrances, exits or in ducts or shafts with unsecured openings to such areas, unless protected against disconnection.
6. Pipelines without detachable connections, valves, control and regulatory devices that are protected against accidental damage may be positioned in public thoroughfares, stairwells or vestibules, provided they are situated at least 2.2 m above the ground.

Pipe brackets

1. Both horizontal and vertical lines must be laid with vibration-damping elements (such as rubber seals). These must be used at a spacing of at least 2 m.
2. The first pipe bracket downstream of the LCP DX and upstream of the condenser should be elastic.

Pipe brackets must not be too close to bends, to allow elongation of lines.

Installing the piping

1. To connect the refrigerant piping system open the line ends on the LCP DX and the condenser. Upon opening, gas must escape audibly (ex works nitrogen filling); this is evidence that there are no leakages in the refrigerating circuit.
2. Cut lines only using a pipe cutting device!
3. Never saw lines open, to prevent generation of sawing swarf!
4. Only solder lines while using nitrogen as a protective gas! To achieve this, introduce dry nitrogen on one end of the line already prepared. Before starting soldering, introduce a generous nitrogen flow, when starting soldering reduce it to a minimum and maintain this low protective gas flow during the entire soldering process.
5. Before soldering the last connection, open one screwed union, to prevent overpressure in the piping system. Upon soldering retighten the connection!
6. As an alternative to soldering you may use crimping. However, limit crimped connections to annealed pipes with a diameter of max. 20 mm! After cutting the pipes, slightly open the pipe to the correct inside diameter. The crimps must be tightened to the correct torque using a torque wrench.

Low-temperature insulation of the liquid lines

1. Liquid cooling outside of the building with low-temperature insulation to DIN 4140 made from UV-resistant HT/Armaflex or an equivalent material.
2. A wall thickness of 9 mm is recommended.

Low-temperature insulation of the hot-gas line

1. The gas line must be insulated indoors (contact hazard protection).

Leak test / conducting the leak test

The system must undergo leak testing as a complete system. Following completion of the system, the test should be carried out at the site of installation.

Multiple techniques may be used to test for leaks, depending on the manufacturing conditions, such as pressurisation with inert gas, or leak detection using radioactive gas. In order to avoid emissions of hazardous substances, the pressure test may be carried out with inert gas such as nitrogen, helium or carbon dioxide. Oxyacetylene and hydrocarbons must not be used for safety reasons. Air and gas mixtures are to be avoided, since certain mixtures may be hazardous.

A vacuum technique may be used for a rough indication of leaks. In order to ensure proper functioning of the cooling system, the manufacturer must specify suitable criteria for the vacuum technique.

The manufacturer must select a test method which allows suitable results to be achieved in accordance with the requirements outlined below.

Connections must be checked with a detector or using a technique with a detection sensitivity as described in EN 1779 with a bubble test (application of liquid) if the test pressure is 1 x PS.



Note:

Lower test pressures are admissible, provided there is an equivalent detection sensitivity.

The manufacturer must verify that the test method used complies with the aforementioned requirements.

EN 1779:1999 may be used as a basis for this test.

The detector must be calibrated at regular intervals as per the manufacturer's instructions.

Any leak detected must be repaired and subjected to a further leak test.

1. Systems with dry nitrogen should be tested at an overpressure of at least 28 bar. The Rotalock valves on the intake and pressure sides of the compressors must be closed. This ensures the compressor is not subjected to the test pressure.
2. Check the system for tightness. We recommend to inspect all connections for tightness, including screwed joints, by spraying with NeKal spray.

Evacuating

1. Upon successful pressure testing, the air still remaining in the system must be removed. To do so, connect a vacuum pump and evacuate the system to a pressure of <0.3 mbar (absolute pressure).
2. If at all possible evacuate from both ends of the compressor, that is from the intake and the pressure side.
3. Fill the system with dry nitrogen and repeat the evacuation. This removes air and remaining moisture from the system.

Filling with refrigerant, cooling system in a vacuum

1. The system must only be filled gravimetrically (i.e. by weight) using refrigerant as the liquid in the liquid line. Fill liquid R410A only until the fill quantity corresponds as precisely as possible to the maximum fill weight as per the rating plate. Thereafter switch the unit on and, while it runs, continue filling carefully and slowly from the intake side of the compressor, until no more bubbles are visible at the sight glass. The maximum fill weight as per the rating plate must not be exceeded.
2. Note the refrigerant volume filled in on the rating plate.
3. Refrigerant filling volumes for unit and condenser see technical data. Determine the refrigerant filling volume for the piping system from the individual lengths and interior diameters of the refrigerant lines.

6 Installation

- The weight of the refrigerant volume actually filled in is determined during filling by means of a refrigerant bottle.

6.3 Cooling water circuit (LCP DX/FC only)

6.3.1 General

Depending on the ambient conditions, in the LCP DX/FC, a water/glycol mixture is circulated between the internal unit and the condenser for indirect free cooling. The concentration of the water/glycol mixture depends on the minimum external temperature and/or frost zone.

6.3.2 Notes on pipework

For the cooling water circuit, analogous to the coolant circuit, the LCP DX/FC must be connected with pipes to the condenser for indirect free cooling. Copper, steel, carbon steel and plastic are all suitable materials for the pipeline system. Generally speaking (where applicable), the notes on laying pipelines in the coolant circuit are also valid here.

The dimension of the connection line is based on the distance between the internal and external unit and must be determined using the pump's characteristic curves (fig. 81).

- Depending on the type of filling (see section 6.3.5 "Filling the cooling water circuit"): When laying the pipework, fit the automatic vent valve included with the supply of the LCP DX/FC at the highest point of the installation.

6.3.3 Determining the quantity of water/glycol

The required quantity of water/glycol is made up as follows:

- Volume of condenser for indirect free cooling: **14 l**
- Volume of heat exchanger in the LCP: **8.4 l**
- Volume of pipeline: Depends on the pipeline length and diameter

Depending on frost protection, up to a **maximum of 30%** of the volume calculated in this way must be replaced with glycol.

6.3.4 Connecting the pipework



Note:

The pipework in the cooling circuit can only be routed upwards out of the device in the factory. This cannot be changed after delivery.

As standard, the pipework is connected to the LCP DX/FC in a downward direction into a raised floor. Connector sleeves are included with the supply for this purpose, and can be fitted to the connector pieces inside the unit.



Fig. 23: Connection points at the bottom of the unit

Key

- Connection point, cooling water inlet
- Connection point, cooling water return

Optionally, the cooling water connections may be routed upwards out of the device in the factory. Connection is then made from above.



Fig. 24: Connection points on the top of the unit

Key

- Connection point, cooling water return
- Connection point, cooling water inlet

6.3.5 Filling the cooling water circuit

After installation, the pipeline must be filled with the water/glycol mixture. Essentially, there are two options here:

- The water/glycol mixture can be pumped in via the KFE tap at the bottom front of the LCP DX/FC. In such cases, an additional vent valve must be installed in the pipeline on the condenser for indirect free cooling.
- Alternatively, the air may be rinsed out of the system. This ensures that the system is quickly and completely vented, to enable optimum subsequent operation of the equipment.

After filling, there must be a working pressure of 3.5 bar in the cooling water circuit. If the pressure is too high, the integral safety valve will open.

Notes on using a scavenging pump for filling

Below, we provide further information on using a scavenging pump to fill the system. Rittal recommends filling the system with this method, because it ensures that there are no air bubbles in the system. It also facilitates reliable, correct blending of the water/glycol mixture.

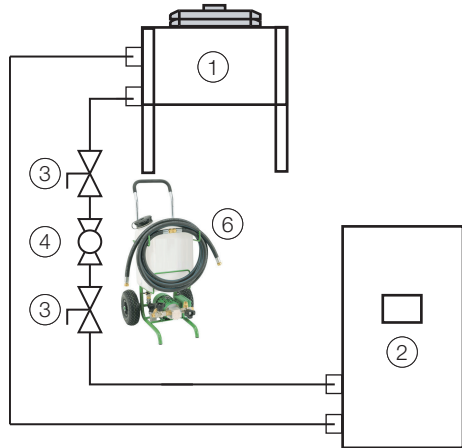

Fig. 25: Additional components in the cooling water circuit

Key

- 1 Condenser for indirect free cooling
- 2 LCP DX
- 3 KFE tap
- 4 Ball valve

- When installing the pipework, additionally fit a ball valve and two KFE taps. Closing the ball valve interrupts the circuit, so that there is an inlet and an outlet for the cooling water circuit on the two KFE taps.
- Connect the discharge port of the scavenging pump to the KFE tap located at the system inlet.
- Connect a hose to the KFE tap located at the system outlet, and route it into the pump tank.
- Gradually pour the required volume of water/glycol mixture into the pump tank.
- Using a refractometer, check the correct glycol concentration in the pump tank.
- Ensure that a pressure of 3.5 bar is set on the filler.
- Fill the circuit using the pump. During the scavenging process, air and returned water/glycol mixture is returned to the pump tank via the system outlet.
- Allow the pump to run until no further air emerges over a long period, and only water/glycol mixture is added to the tank.

6.4 Connecting the condensate discharge

Any condensate which may develop is collected in the condensate collecting tray (fig. 26, item 1) beneath the heat exchanger.



Fig. 26: Condensate discharge

Key

- 1 Condensate collecting tray
- 2 Condensate discharge hose
- 3 Hose condensate

The LCP DX is additionally equipped with a condensate discharge via which the condensate is pressurelessly routed out of the LCP DX.

A hose ($\varnothing_i = 16 \text{ mm}$, length = 2 m) is connected to the condensate discharge in the factory (fig. 26, item 2). This hose, in turn, must be routed to a drain with odour seal by the customer, so that any condensate can be discharged from the device. The LCP DX may optionally be fitted with a condensate pump in addition to this (see section 15.5 "Condensate pump").



Note:

In order to ensure safe condensate discharge, the following points should be observed:

- Lay the drainage hose so that it always runs downhill and without any kinks.
- Do not constrict the hose cross section.

LCP DX/FC version only

There is a safety valve integrated into the cooling water circuit which trips automatically if the pressure is too high. There is an outlet pipe installed on this valve.



Fig. 27: Safety valve at rear

Key

- 1 Safety valve
- 2 Outlet pipe

6 Installation

Depending on the national regulations, the outlet pipe from the safety valve must be connected to a collecting tank. This prevents water/glycol mixture from entering the sewerage system if the safety valve is tripped.

- Additionally, fit a collecting tank underneath the condenser for indirect free cooling.

6.5 Electrical connection

6.5.1 General



Note:

Please keep the wiring plan readily available so that it is always on hand when needed. This is the only authoritative documentation for this unit.

6



Caution!

Work on electrical systems or equipment may only be carried out by an electrician or by trained personnel under the guidance and supervision of an electrician. All work must be carried out in accordance with electrical engineering regulations.

Contact with live electrical parts may be lethal.

The unit may only be connected after the personnel mentioned above have read this information!

Use only insulated tools.

The connection regulations of the appropriate electrical power company are to be followed.

The voltage values shown in the wiring plan or on the rating plate must match the mains voltage.

The pre-fuse specified in the wiring plan / rating plate should be provided to protect the cable and equipment from short-circuits. The unit must be individually fused.

The unit has a high discharge current. Before connecting to the supply circuit, therefore, it is essential to make a 6 mm² earth connection (see section 16.7 "Circuit diagram").



Caution!

No additional control equipment may be connected upstream of the device at the supply end.

With the LCP DX, the internal device and the external condenser are supplied with voltage independently of one another. With the LCP DX, the condenser for indirect free cooling is connected directly to the LCP DX, which supplies it with the required operating voltage.

6.5.2 Connecting the power supply

Power is supplied to the LCP DX via a 5-wire connection cable (380...415 V, 3~, N, PE). The cable is routed into the device from the rear, and from there, inserted into the electronics box.

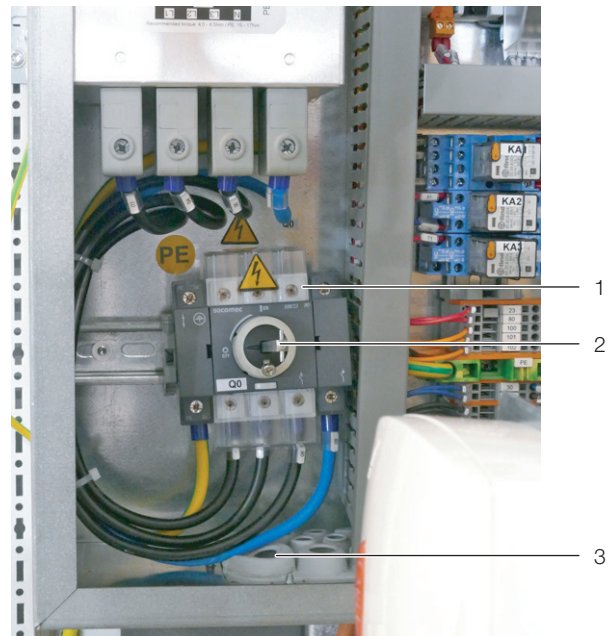

Fig. 28: Opened electronics box

Key

- 1 Connection clamps
- 2 Master switch
- 3 Cable entry, electronics box

The cable is inserted into the electronics box from below (fig. 28, item 3). Inside the electronics box, it is connected to the correspondingly labelled terminals on the master switch (PE, L1, L2, L3, N).

- Remove approximately 45 mm from the rubber sheathing of the flexible cable.
- Trim the neutral conductor (N) and the three phase conductors (L1, L2, and L3) to a length of approximately 35 mm. Leave the length of the PE conductor at approximately 45 mm.
- Remove approximately 9 mm from the insulation of all conductors with a suitable tool.

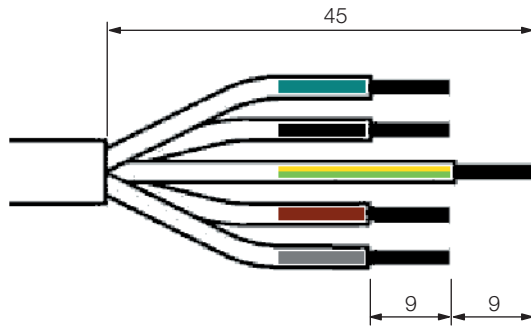

Fig. 29: Dimensions for removing the rubber sheathing and insulation

- Attach wire end ferrules without insulating collar to the ends of the cables, using a four-jaw pressing tool.



Note:

A voltage of at least 380 V is required to start the device.

If the mains voltage briefly drops 10% below 380 V with the system operational, it will not malfunction.

- The customer should provide a pre-fuse in the supply line to the LCP DX, as specified on the rating plate of the device.



Danger!

Take utmost care not to short-circuit one of the phases with the zero conductor or the earth conductor. Otherwise, there is a risk of damage or injury.

6.5.3 Connecting the external condenser (LCP DX only)

Connecting the external condenser entails simply plugging it into the external power supply. Internally, the condenser is fully wired, and no connection is needed between the LCP DX and the external condenser (via a data cable etc.). The fan speed of the condenser is controlled via the system pressure.



Fig. 30: Electrical connection on the external condenser

Key

- 1 Connection clamps 230 V, 1~, N
- 2 Cable gland
- 3 Connection clamp PE

Power is supplied to the external condenser via a 3-wire connection cable (230 V, 1~, N, PE). The 3-wire cable must be inserted into the junction box of the external condenser from below. The main switch is wired to the fan control in the factory, and the pressure transducer is mechanically and electrically connected to the condenser.

Once the power supply is connected to the master switch:

- Rotate the main switch into the "I" position.

The fans will start up as soon as the LCP DX is switched on.

6.5.4 Electrical connection of the condenser for indirect free cooling (LCP DX/FC only)

To connect the condenser for indirect free cooling, both the cable for the power supply and several control/signal cables must be routed from the LCP DX to the external unit. Internally, the condenser for indirect free cooling is fully cabled. Specifically, the following connection cables are required:

- 4-wire connection cable (4 x 2.5 mm²): Power supply to the condenser for indirect free cooling (380...415 V, 3~, PE)
- 2-wire cable (2 x 1.5 mm²): Signal cable 0-10 V/0 V to control the fan speed
- 2-wire cable (2 x 1.5 mm²): Signal cable "Alarm, condenser for indirect free cooling"
- 2-wire cable (2 x 1.5 mm²): Signal cable "Pressure transducer"
- 2-wire cable (2 x 1.5 mm²): Signal cable "External temperature"

6 Installation

6

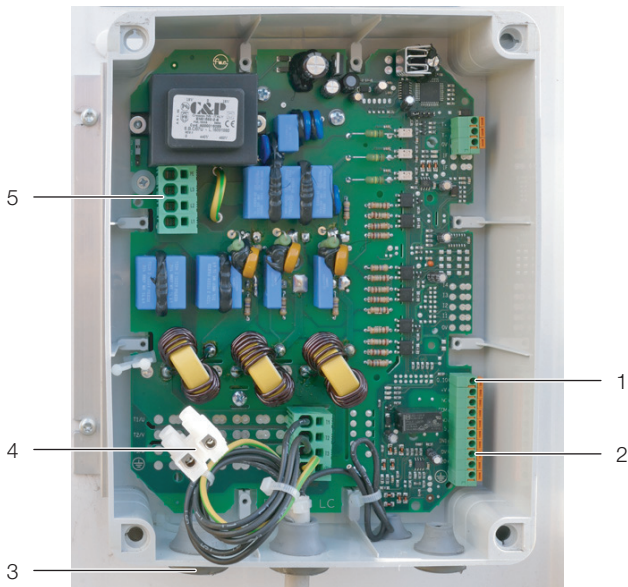

Fig. 31: Electrical connection on the condenser for indirect free cooling

Key

- 1 Signal cable 0-10 V (fan speed of LCP DX/FC)
- 2 Signal cable 0 V (fan speed of LCP DX/FC)
- 3 Cable gland
- 4 Signal cable "Alarm condenser for indirect free cooling" (to LCP DX/FC)
- 5 Connection clamps 380 V, 3~, PE (from LCP DX/FC)

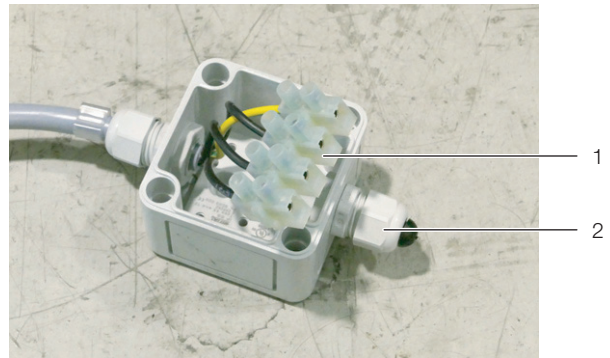

Fig. 33: Electrical connection on the LCP DX/FC

Key

- 1 Connection clamps
- 2 Cable gland

- Insert the connection cable through the cable gland into the connection box on the LCP DX/FC.
- Connect the cable to the connection clamps and then route the cable to the condenser for indirect free cooling.

The voltage supply in the connection box (fig. 31, item 3) is connected on the condenser for indirect free cooling.

- Insert the connection cable through the cable gland into the connection box to the condenser for indirect free cooling.
- Connect the cable to the connection clamps (fig. 31, item 5).

The control and/or signal cables must likewise be laid between the relevant connection points on the condenser for indirect free cooling (fig. 31, item 1, 2 and 4 and fig. 32, item 2) and the electronics box on the LCP DX/FC. Connection to the X2A terminal strip is made inside the electronics box.



Fig. 32: Connection of sensors

Key

- 1 Pressure transducer
- 2 Signal cables
- 3 Temperature sensor
- 4 Condenser unit

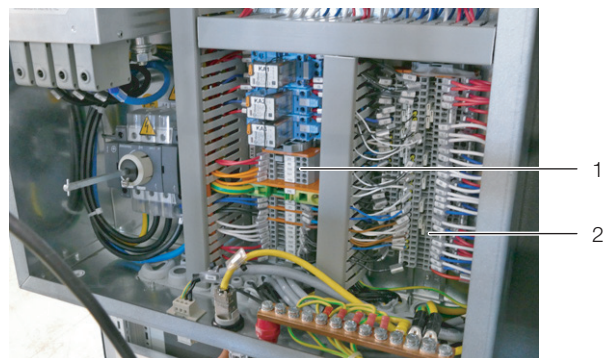

Fig. 34: Terminal strips X1A and X2A in the electronics box

Key

- 1 Terminal strip X1A
- 2 Terminal strip X2A

Power is supplied via a 4-wire connection cable (380 V, 3~, N, PE). The 4-wire cable is connected to the LCP DX/FC in the connection box near the water pump (fig. 6, item 1).

**Note:**

Further information on the precise connection points can be found in the circuit diagram for the LCP DX/FC supplied loose with the device.

- Signal cable "Pressure transducer": Connection clamps 98 and 99
- Signal cable "Fan speed": Connection clamps 54 and 55
- Signal cable "Alarm, condenser for indirect free cooling": Connection clamps 52 and 53
- Signal cable "External temperature": Connection clamps 81 and 85

Once the power supply and the pilot wires have been connected:

- Rotate the main switch into the "I" position.
The fans will start up as soon as the LCP DX is switched on.

6.6 Checking the entire system prior to commissioning

Before operating the LCP DX, the entire system, including the complete cooling system, must be checked for conformity with the relevant diagrams, flow charts and piping and instrumentation diagrams of the system and wiring plans.

Cooling systems must be checked by a trained plant inspector (as defined in EN 13313) and should include a review of the following points:

1. Inspect the documents.
2. Check the safety switchgear for pressure limiting. In this connection, it is important to check that the safety switchgear for pressure limiting is operational and correctly installed.
3. Check selected hard solder connections on pipe-work for compliance with EN 14276-2.
4. Check the refrigerant pipelines.
5. Inspect the report on the cooling system leak test.
6. Visually inspect the cooling system.
7. Check the labels.

This inspection must be documented; see EN 378-2, section 6.4.3. No cooling system may be operated without the correct documentation.

The installer must document the fact that the system was installed in accordance with the construction requirements and state the safety and control device settings, if adjustable, following commissioning. This documentation must be kept by the installer and presented upon request.

7 Operation

This section describes operation of the LCP DX using the control and display devices directly on the unit itself. Using the built-in pCO Web card, it is also possible to access the unit via a network connection (see section 7.13 "Configure the pCO Web card" and section 14 "SNMP card").

7.1 Control and display components



Fig. 35: Control and display components

Key

- 1 Display
- 2 "Up" button
- 3 "Return" button
- 4 "Down" button
- 5 "Esc" button
- 6 "Prg" button
- 7 "Alarm" button

7.2 Switching the LCP DX on and off

7.2.1 Switching on the LCP DX and the external condenser

Once both the LCP DX and the external condenser or the condenser for indirect free cooling are electrically connected and switched on at their respective master switches, carry out the following two steps:

- If you wish to switch the LCP DX on and off remotely: In the electronics box at the terminal strip X1A, remove the jumper between the two terminals 30 and 80 ("Remote On-Off") and connect a floating remote switch (normally open contact) (fig. 34, item 1). If the two terminals are not jumpered, the status message "Din-Off" will appear in the display.
- Change the status of the device in the "On/Off Unit" menu from "Off" to "On" (see section 7.6 "Menu level A "On/Off Unit").

7.2.2 Switching off the LCP DX and the external condenser

To switch off the LCP DX and the external condenser or the condenser for indirect free cooling, proceed as follows:

- Change the status of the device in the "On/Off Unit" menu from "On" to "Off" (see section 7.6 "Menu level A "On/Off Unit").

- Switch off the LCP DX and the external condenser or the condenser for indirect free cooling at their respective master switches.

7.2.3 Switching off in an emergency

To switch off the LCP DX and the condenser, proceed as follows:

- Switch off the LCP DX and the external condenser or the condenser for indirect free cooling at their respective master switches.

7.3 Layout of the user interface

The user interface is divided into eight menu levels. This level and, where applicable, the level below is displayed in the top right of every menu.

- Level A: Switch the device on and off
- Level B: Enter settings
- Level C: Set time and date
- Level D: View the status of inputs and outputs
- Level E: View and confirm error messages
- Level F: Replace the motherboard
- Level G: Edit basic settings (service)
- Level H: Edit basic settings (manufacturer)

7.4 General operating instructions

You can use the buttons on the command panel to move between the different menu levels and menus and change parameter settings.

7.4.1 Moving between menus

- Press the "Prg" button to move from the start screen to the main menu.
- Press the "Up" or "Down" button to select the entries (sub-menus) in a menu.
- Press the "Return" button to move to the selected sub-menu.
- Press the "Esc" button to move from a sub-menu to the menu above.

7.4.2 Changing parameter values

- Press the "Up" or "Down" button to select the entries (parameters) in a menu.
- Press the "Return" button to change the selected parameter value.
- Press the "Up" button to increase the parameter value, and the "Down" button to reduce the parameter value.
- Press the "Return" button to confirm the amended parameter value.
- Press the "Esc" button to move to the menu above.

7.5 Start screen

Current basic parameters are displayed on the start screen whilst the device is operational.



Fig. 36: Start screen

Key

- 1 Air inlet temperature
- 2 Air outlet temperature
- 3 Status of LCP DX
- 4 Status of fan speed
- 5 Status of compressor
- 6 Time and date

7.6 Menu level A "On/Off Unit"

Use this menu to switch the device on and off.

- Press the "Prg" button to move from the start screen to the main menu.
- Press the "Up" or "Down" button to select the entry "A. On/Off Menu".
- Press the "Return" button to move to the selected sub-menu.

7.6.1 Menu A01

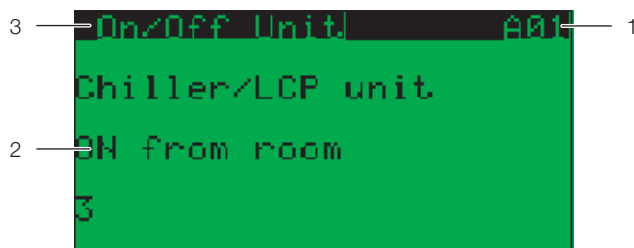

Fig. 37: Menu A01

Key

- 1 Menu level A01
- 2 Parameter "ON/OFF"
- 3 Menu "On/Off Unit"

To switch on the device:

- Press the "Down" button to select the "OFF" entry.
- Press the "Return" button to edit the selected parameter value.
- Press the "Up" or "Down" button to change the parameter value to "ON".
- Press the "Return" button to confirm the amended parameter value.
The device is now switched on.
- Press the "Esc" button to move back to the start screen.

To switch off the device:

- Press the "Down" button to select the "ON" entry.
- Press the "Return" button to edit the selected parameter value.

- Press the "Up" or "Down" button to change the parameter value to "OFF".
- Press the "Return" button to confirm the amended parameter value.
The device is now switched off.
- Press the "Esc" button to move back to the start screen.

7.6.2 Menu A02

A sleep mode may be activated in menu A02. As the LCP DX adapts to the required cooling output in any case, settings are not generally required here.

7.7 Menu level B "Setpoint"

7.7.1 Menu B01

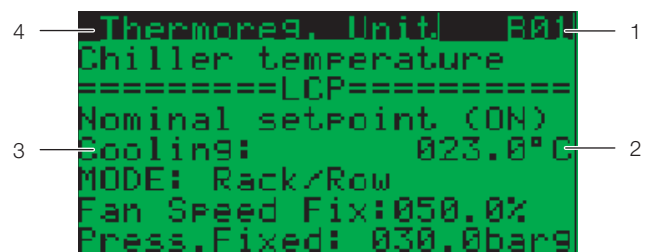

Fig. 38: "Setpoint" menu

Key

- 1 Menu level B01
- 2 Current setting
- 3 "Cooling" parameter
- 4 "Thermo-reg. unit" menu

Parameter	Explanation
Cooling	Current setting for setpoint temperature.
MODE	Operating mode of device.
Fan Speed Fix	Set a fixed fan speed.

Tab. 6: Settings in menu B01

7.7.2 Menu B02

Parameter	Explanation
Enable Alarm	Activate an alarm when the limits specified below are exceeded.
Setpoint Diff.	Difference between the actual temperature and the setpoint temperature.
Setpoint ABS	Absolute maximum temperature.
Hysteresis	If both the above limits are exceeded, an alarm is output immediately. The alarm stops when the respective limit is undercut by the value specified here.
Delay Alarm	Time delay by which the alarm is output.

Tab. 7: Settings in menu B02

7 Operation

7.8 Menu level C "Clock/Scheduler"

7.8.1 Menu C01

Set the current time and date in menu C01.

- Press the "Return" button, and the numerical display for the day will start to flash.
- Press the "Up" or "Down" button to change the value for the day.
- Press the "Return" button to move to the entry for the month.
- Again, press the "Up" or "Down" button to change the value for the month.
- Proceed in the same way to set the year, hours and minutes. The display of the week day will change automatically according to the set date.

Parameter	Explanation
Day	Displays the day of the week.
Date	Today's date in the format dd/mm/yy.
Hour	Current time.

Tab. 8: Settings in menu C01

7.8.2 Menu C02 – C04

In menus C02 to C04 it is possible to switch off the device on certain days (such as public holidays) or for a specified period (e.g. factory shutdown). As the LCP DX adapts to the required cooling output in any case, settings are not generally required here.

7.8.3 Menu C05

Settings for the changeover to summertime may be made in menu C05.

Parameter	Explanation
DST	Activate or deactivate the changeover to summertime.
Transition time	No. of minutes by which the clock is set forward or back.
Start	Start of changeover to summertime (e.g. "last Sunday in March at 2.00 am").
End	End of changeover to summertime (e.g. "last Sunday in October at 3.00 am").

Tab. 9: Settings in menu C05

7.9 Menu level D "Input/Output"

The current values of the digital and analog inputs and outputs are displayed in menu level D. We have not included a detailed representation of all parameters, since these displays are not required in normal operation.

7.9.1 Menu D01 – D06

The current values of the analog inputs are displayed in menus D01 to D06.

7.9.2 Menu D07 – D12

The current values of the digital inputs are displayed in menus D07 to D12.

7.9.3 Menu D13

The current values of the analog outputs are displayed in menu D13.

7.9.4 Menu D14

The following parameters of the electronic expansion valve are displayed in an overview screen in menu D14.

- Superheat
- Degree of opening of the valve in %
- Evaporation pressure
- Evaporation temperature



Fig. 39: Menu D14

7.9.5 Input/output menu

Other parameters of inputs and outputs are displayed in the input/output menu. The following parameters showing the compressor's current consumption levels can be viewed here.

Parameter	Explanation
Motor current	Current power consumption of the compressor motor [109].
Motor voltage	Current voltage of the compressor motor [111].

Tab. 10: Displays in the Power+ n°1 menu (3/6)

Parameter	Explanation
Motor power	Current output of the compressor motor [110].

Tab. 11: Displays in the Power+ n°1 menu (4/6)

7.10 Menu level E "Data logger"

7.10.1 Menu E01

Error messages are displayed in menu E01 and in the following menus E02, E03 etc. (see section 8.1 "General").

7.11 Menu level F "Board switch"

The pLAN device addresses of the display and the motherboard are displayed in menu F01. This may be

helpful following an exchange of the respective hardware component.

Parameter	Explanation
Unit address	pLAN device address of display and motherboard

Tab. 12: Displays in menu F01

7.12 Menu level G "Service"

7.12.1 Menu Ga "Change language"

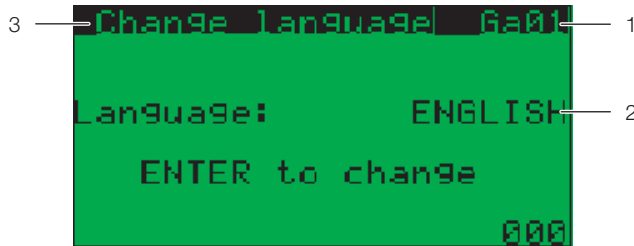

Fig. 40: Menu A01

Key

- 1 Menu level Ga01
- 2 Currently selected language
- 3 Menu "Change language"

- Keep pressing the "Return" button until your preferred language is selected.

Parameter	Explanation
Disable language mask at start-up	Activate or deactivate language selection when the device is booted up.
Show mask time	Period for which the language selection is displayed.

Tab. 13: Settings in menu Ga02

7.12.2 Menu Gb "Information"

Information on the individual software and hardware components is displayed in menus Gb01 to Gb05.

7.12.3 Menu Gd "Working hours"

The operating hours of the device as a whole and its individual components are displayed in menu Gd01 and Gd02.

7.13 Configure the pCO Web card

The pCO Web card has a Web server with pages on how to configure the card. The following browsers are supported:

- Microsoft Internet Explorer
- Mozilla Firefox

7.13.1 Activate the factory bootswitch parameters



Note:

The pCO Web card 3311.320 with software version 1.1 is only compatible with LCP DX device software version 1.3.



Note:

No root access is possible with the pCO Web card with software version 1.1.

The pCO Web card is configured as standard as a DHCP client. If DHCP is not used in your network, you can set the card to a fixed IP address by activating the bootswitch parameters. Activation is achieved by pressing the Reset button when booting up the card.



Danger! Electric shock!

Contact with live electrical parts can be lethal.

The following work must only be carried out by suitably trained, qualified personnel.

- Open the electronics box in the LCP DX.
- Switch on the LCP DX at the master switch.

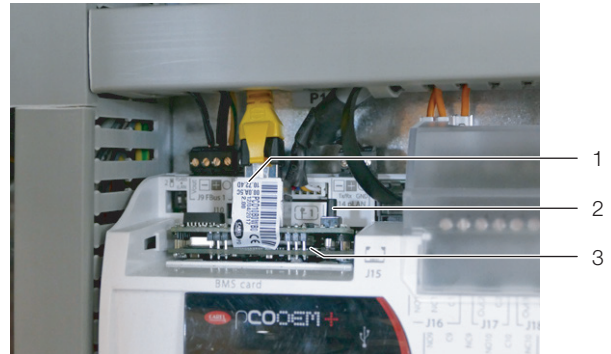

Fig. 41: pCO Web card

Key

- 1 Ethernet socket with sticker MAC address
- 2 Reset button
- 3 pCO Web card

- Press the Reset button (fig. 41, item 2), if necessary with the assistance of a second person, and keep it held down for around 20 seconds whilst the card is booting up, until the status LED flashes three times slowly.



Caution! Risk of injury and risk of malfunction or damage!

When carrying out a reset on the pCO Web card, please be careful not to touch any other electronic components.

7 Operation

- Release the Reset button whilst the status LED is flashing.
- Make a note of the MAC address, which can be found on the sticker on the Ethernet jack.
You may need this later on to ascertain the device's IP address.

After a further 50 seconds or so, the card can be accessed under the IP address 172.16.0.1.

- Then close the electronics box again.

7.13.2 Logging on to the pCO Web card

- If DHCP is used in your network: Notify your network administrator of the pCO Web card's MAC address, then request the card's IP address from him/her. The MAC address can be found on a sticker on the Ethernet socket of the pCO Web card, and additionally on a small sticker on the card's protective cover.

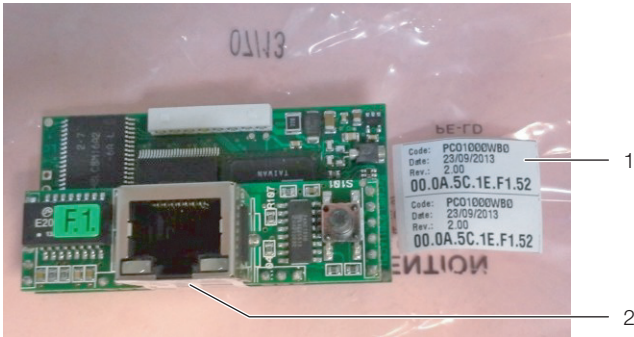

Fig. 42: MAC address

Key

- 1 Two stickers on the packaging
- 2 Ethernet socket with sticker MAC address

- If DHCP is not used in your network: Activate the bootswitch parameters (see section 7.2.2 "Switching off the LCP DX and the external condenser").
- Open the browser and enter the IP address of the pCO Web card in the address line, together with the suffix "/config".

Example of a static IP address:
http://172.16.0.1/config

The following dialogue will appear for logging on to the Web server.

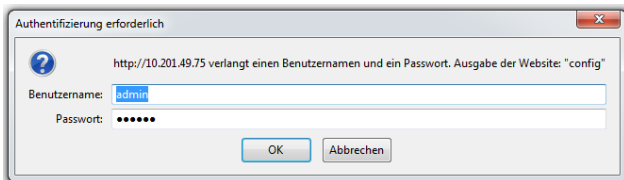

Fig. 43: Authentication on the pCO Web card

- Enter **admin** as the user and **fadmin** as the password.
- Once you have successfully logged in, the homepage of the pCO Web card will launch.

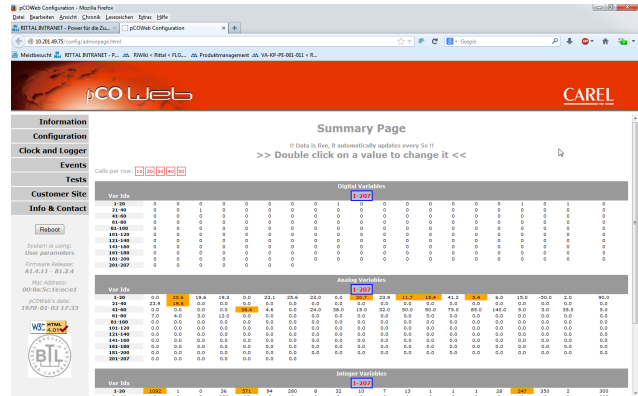

Fig. 44: Homepage of the pCO Web card



Caution! Risk of malfunction or damage!

Double-clicking on a variable will open the variables window. Every variable represented by the pCO Web controller can be edited, provided you have write permission. Editing these variables could result in an LCP DX malfunction. Download the list of data points from the website shown in the Foreword, and use this list to check the meaning of the variables and their minimum and maximum values.

7.13.3 Configure the network interface

Network settings are made under the menu point **Configuration > Network**. Here, you can assign an IP address and up to three aliases to the network interface. The aliases do not have their own gateway address.



Fig. 45: Network configuration

- Enter the fixed IP address via which you wish to access the network interface under **Eth0** in the **IP Address main** field.
- Alternatively, you may leave this field blank or enter **DHCP** if you would like an IP address to be automatically assigned to the network interface via DHCP.

- If applicable, enter the corresponding alias addresses in the **IP Alias 1**, **IP Alias 2** and **IP Alias 3** fields.
- Transfer these changes to the controller by clicking on the **Submit** button.
- Reboot to activate the changes.

7.13.4 E-mail configuration

The parameters listed in the supervisory table (see section 7.13.5 "LCP DX supervisory table") can be used to configure various events for notification by e-mail.

- The procedure for configuration is described in the original user instructions for the pCO Web card from Carel.

These instructions can be found at the following address:

http://www.carel.com/carelcom/web/eng/catalogo/prodotto_dett.jsp?id_gamma=39&id_prodotto=350&id_mercato=4

7 Operation

7.13.5 LCP DX supervisory table

Tab. 14: LCP DX supervisory table – analogue variables

BMS Address	Description	UOM	Min	Max	Read/Write	Note
1	B1 probe value: Saturation Temperature (optional)	°C	-99,9	99,9	R	Customer
2	B2 probe value: LCP Server IN	°C	-99,9	99,9	R	Customer
3	B3 probe value: LCP Server IN	°C	-99,9	99,9	R	Customer
4	B4 probe value: Ambient Temperature (optional)	°C	-99,9	99,9	R	Customer
5	B5 probe value: Humidity Return (optional)	%	0	100	R	Customer
6	B6 probe value: ROOM Server OUT	°C	-99,9	99,9	R	Customer
7	B7 probe value: ROOM Server OUT	°C	-99,9	99,9	R	Customer
8	B8 probe value: Remote Condenser Pressure (optional)	bar	-99,9	99,9	R	Customer
9	B9 Probe value: Compressor discharge temperature	°C	-99,9	99,9	R	Customer
10	B10 Probe value: Compressor suction temperature	°C	-99,9	99,9	R	Customer
11	B11 probe value: High pressure - Compressor Discharge Pressure	bar	-99,9	99,9	R	Customer
12	B12 probe value: Low pressure - Compressor Suction Pressure	bar	-99,9	99,9	R	Customer
13	Evaporator temperature from Low pressure conversion	°C	-99,9	99,9	R	Customer
14	Condensing temperature from High pressure conversion	°C	-99,9	99,9	R	Customer
15-20	Reserved - (not used or other special application or internal debug)	---	---	---	---	only for Service/Manufacturer
21	Server Medium Temp Out - (Room)	°C	-99,9	99,9	R	Customer
22	Server Medium Temp In - (LCP)	°C	-99,9	99,9	R	Customer
23-44	Reserved - (not used or other special application or internal debug)	---	---	---	---	only for Service/Manufacturer
45	Compressor Rotor speed	rps	0	999,9	R	Customer
46	Compressor Motor current	Amp	0	99,9	R	Customer
47	Reserved - (not used or other special application or internal debug)	rps	0	999,9	R	only for Service/Manufacturer
48	Main Setpoint LCP	°C	-99,9	99,9	R/W	Customer
49-207	Reserved - (not used or other special application or internal debug)	---	---	---	---	only for Service/Manufacturer

Tab. 15: LCP DX supervisory table – integer variables

BMS Address	Description	UOM	Min	Max	Read/Write	Note
1	Compressor Rotor speed	Hz	0	9999	R	only for Service/Manufacturer
2	Driver Power+ status (0:Stop; 1:Run; 2:Alarm)	---	0	2	R	only for Service/Manufacturer
3	Current error code (0: No fault; 1: Overcurrent; 2: Motor overload; 3: Overvoltage; 4: undervoltage; 5: Drive overTemp; 6: Drive underTemp; 7: Overcurrent HW; 8: Motor overtemp; 9: Drive failure; 10: Cpu error; 11: Param. default; 12: DC bus ripple; 13: Data comms fault; 14: Drive thermistor; 15: Auto-tune fault; 16: Drive disabled; 17: Motor phase; 18: Fan fault; 19: Speed fault; 20: PFC failure; 21: error code 21; 22: PFC undervoltage; 23: STO survey fail; 24: STO survey fail; 25: error code 25; 26: error code 26; 27: error code 27; 28: error code 28; 29: error code 29; 30: error code 30;... 99: Unexpected stop;)	---	0	99	R	only for Service/Manufacturer
4	Driver Power+ temperature	°C	-999	999	R	only for Service/Manufacturer
5	Power+ DC Bus Voltage	V	0	999	R	only for Service/Manufacturer
6	Motor Voltage	V	-9999	9999	R	only for Service/Manufacturer
7	Request of power for inverter after envelop	%	0	1000	R	only for Service/Manufacturer
8	Current hour	---	0	23	R	Customer
9	Current minute	---	0	59	R	Customer
10	Current month	---	1	12	R	Customer
11	Current weekday (1: Monday; 2: Tuesday; 3: Wednesday; 4: Thursday; 5: Friday; 6: Saturday; 7: Sunday;)	---	1	7	R	Customer
12	Current year	---	0	99	R	Customer
13	Unit On-Off (0=Off; 1=On)	---	0	1	R/W	Customer
14	Envelope Zone: 0=OK; 1=Max.compr.ratio; 2=Max.disch.P.; 3=Curr.limit; 4=Max.suct.P.; 5=Min.compr.ratio; 6=Min.DeltaP; 7=Min.disch.P.; 8=Min.suct.P.	---	0	9	R	only for Service/Manufacturer
15	HT Zone: 0:null, 1: Disch.T. OK; 2: Disch.T. inside control zone=reduce speed rate; 3: Disch.T. >thr=speed reduction	---	0	32767	R	only for Service/Manufacturer
16	Actual circuit cooling capacity for EVD valve	%	0	100	R	only for Service/Manufacturer
17	EVD Valve steps position	steps	0	540	R	Customer

7 Operation

Tab. 15: LCP DX supervisory table – integer variables

BMS Address	Description	UOM	Min	Max	Read/Write	Note
18	Output Y3 value: Fans Speed (signal 0-1000)	%	0	1000	R	Customer
19-20	Reserved - (not used or other special application or internal debug)	---	---	---	---	only for Service/Manufacturer
21	Output Y1 value: Remote Condenser Fans (signal 0-1000)(optional)	%	0	1000	R	Customer
22	Output Y2 value: FreeCooling Pump Speed (signal 0-1000)(optional)	%	0	1000	R	Customer
23-26	Reserved - (not used or other special application or internal debug)	---	---	---	---	only for Service/Manufacturer
27	Current day	---	1	31	R	Customer
28	Fans Speed (percent)	%	0	100	R	Customer
29	Fans Speed (rpm)	rpm	0	3700	R	Customer
30	EVD Valve opening percent	%	0	100	R	Customer
31-207	Reserved - (not used or other special application or internal debug)	---	---	---	---	only for Service/Manufacturer

Tab. 16: LCP DX supervisory table – digital variables

BMS Address	Description	UOM	Min	Max	Read/Write	Note
1	Digital input 1: Remote Condenser Alarm (optional)	---	0	1	R	Customer
2	Digital input 2: Drive/Compressor Overload	---	0	1	R	Customer
3	Digital input 3: High Pressure Switch	---	0	1	R	Customer
4	Digital input 4: Low Pressure Switch (optional)	---	0	1	R	Customer
5-6	Reserved - (not used or other special application or internal debug)	---	0	1	R	only for Service/Manufacturer
7	Digital input 7: Fans Overload Alarm	---	0	1	R	Customer
8	Digital input 8: Pump Overload Alarm	---	0	1	R	Customer
9	Digital input 9: Filter Clogged Alarm (optional)	---	0	1	R	Customer
10	Digital input 10: Remote ON/OFF	---	0	1	R	Customer
11	General Inverter Alarm	---	0	1	R	Customer
12	Power+ Drive Off-Line Alarm	---	0	1	R	Customer
13	Mode Regulation (0=RACK/ROW; 1=ROOM)	---	0	1	R	Customer
14	Digital output 13: Pre/Post Heater 3 On (optional)	---	0	1	R	Customer
15-16	Reserved - (not used or other special application or internal debug)	---	0	1	R	only for Service/Manufacturer
17	Digital output 1: General alarm Contact	---	0	1	R	Customer
18-21	Reserved - (not used or other special application or internal debug)	---	0	1	R	only for Service/Manufacturer
22	Digital output 6: FreeCooling Pump On (optional)	---	0	1	R	Customer
23-26	Reserved - (not used or other special application or internal debug)	---	0	1	R	only for Service/Manufacturer
27	Digital output 11: Pre/Post Heater 1 On (optional)	---	0	1	R	Customer
28	Digital output 12: Pre/Post Heater 2 On (optional)	---	0	1	R	Customer
29	Command to reset all alarms by Supervisor	---	0	1	R/W	only for Service/Manufacturer
30	Envelope Alarm: Memory alarm compressor forced off working out envelope	---	0	1	R	only for Service/Manufacturer
31	Compressor startup failure alarm: reach max retry number	---	0	1	R	only for Service/Manufacturer
32	Compressor startup failure alarm used for the alarm mask visualization	---	0	1	R	only for Service/Manufacturer

7 Operation

Tab. 16: LCP DX supervisory table – digital variables

BMS Ad- dress	Description	UOM	Min	Max	Read/ Write	Note
33	Memory Alarm max discharge temperature	---	0	1	R	only for Service/ Manufacturer
34	Reserved - (not used or other special appli- cation or internal debug)	---	0	1	R	only for Service/ Manufacturer
35	Memory alarm Delta pressure too big to startup compressor	---	0	1	R	only for Service/ Manufacturer
36	Memory alarm control for oil return when compressor is running (lubrication)	---	0	1	R	only for Service/ Manufacturer
37	Memory alarm probe broken (analogic input B1): Saturation Temperature (optional)	---	0	1	R	only for Service/ Manufacturer
38	Memory alarm probe broken (analogic input B2): LCP Server IN	---	0	1	R	only for Service/ Manufacturer
39	Memory alarm probe broken (analogic input B3): LCP Server IN	---	0	1	R	only for Service/ Manufacturer
40	Memory alarm probe broken (analogic input B4): Ambient Temperature (optional)	---	0	1	R	only for Service/ Manufacturer
41	Memory alarm probe broken (analogic input B5): Humidity Return (optional)	---	0	1	R	only for Service/ Manufacturer
42	Memory alarm probe broken (analogic input B6): ROOM Server OUT	---	0	1	R	only for Service/ Manufacturer
43	Memory alarm probe broken (analogic input B7): ROOM Server OUT	---	0	1	R	only for Service/ Manufacturer
44	Memory alarm probe broken (analogic input B8): Remote Condenser Pressure (optional)	---	0	1	R	only for Service/ Manufacturer
45	Memory alarm probe broken (analogic input B9): Compressor Discharge Temperature	---	0	1	R	only for Service/ Manufacturer
46	Memory alarm probe broken (analogic input B10): Compressor Suction Temperature	---	0	1	R	only for Service/ Manufacturer
47	Memory alarm probe broken (analogic input B11): Compressor Discharge Pressure	---	0	1	R	only for Service/ Manufacturer
48	Memory alarm probe broken (analogic input B12): Compressor Suction Pressure	---	0	1	R	only for Service/ Manufacturer
49-99	Reserved - (not used or other special appli- cation or internal debug)	---	0	1	R	only for Service/ Manufacturer
100	Reserved - (not used or other special appli- cation or internal debug) / System reboot	---	0	1	R/W	only for Service/ Manufacturer
101	Alarm probe broken (analogic input B1): Sat- uration Temperature (optional)	---	0	1	R	Customer
102	Alarm probe broken (analogic input B2): LCP Server IN	---	0	1	R	Customer
103	Alarm probe broken (analogic input B3): LCP Server IN	---	0	1	R	Customer
104	Alarm probe broken (analogic input B4): Am- bient Temperature (optional)	---	0	1	R	Customer

Tab. 16: LCP DX supervisory table – digital variables

BMS Ad- dress	Description	UOM	Min	Max	Read/ Write	Note
105	Alarm probe broken (analogic input B5): Hu- midity Return (optional)	---	0	1	R	Customer
106	Alarm probe broken (analogic input B6): ROOM Server OUT	---	0	1	R	Customer
107	Alarm probe broken (analogic input B7): ROOM Server OUT	---	0	1	R	Customer
108	Alarm probe broken (analogic input B8): Re- mote Condenser Pressure (optional)	---	0	1	R	Customer
109	Alarm probe broken (analogic input B9): Compressor Discharge Temperature	---	0	1	R	Customer
110	Alarm probe broken (analogic input B10): Compressor Suction Temperature	---	0	1	R	Customer
111	Alarm probe broken (analogic input B11): Compressor Discharge Pressure	---	0	1	R	Customer
112	Alarm probe broken (analogic input B12): Compressor Suction Pressure	---	0	1	R	Customer
113	High pressure alarm by pressostat	---	0	1	R	Customer
114	High pressure alarm by transducer	---	0	1	R	Customer
115	Low pressure alarm by transducer	---	0	1	R	Customer
116	Compressor overload alarm	---	0	1	R	Customer
117-118	Reserved - (not used or other special appli- cation or internal debug)	---	0	1	R	only for Service/ Manufacturer
119	Envelope Alarm: alarm compressor forced off working out envelope	---	0	1	R	Customer
120	Compressor startup failure alarm used for the alarm mask visualization	---	0	1	R	Customer
121	Alarm max. discharge temperature	---	0	1	R	Customer
122	Alarm control for oil return when compressor is running (lubrication)	---	0	1	R	Customer
123	Reserved - (not used or other special appli- cation or internal debug)	---	0	1	R	only for Service/ Manufacturer
124	FreeCooling Pump alarm (optional)	---	0	1	R	Customer
125-128	Reserved - (not used or other special appli- cation or internal debug)	---	0	1	R	only for Service/ Manufacturer
129	Fans Overload Alarm	---	0	1	R	Customer
130-142	Reserved - (not used or other special appli- cation or internal debug)	---	0	1	R	only for Service/ Manufacturer
143	Max. Temperature alarm	---	0	1	R	Customer
144-152	Reserved - (not used or other special appli- cation or internal debug)	---	0	1	R	only for Service/ Manufacturer
153	Power+ Drive Off-Line Alarm	---	0	1	R	Customer

7 Operation

Tab. 16: LCP DX supervisory table – digital variables

BMS Address	Description	UOM	Min	Max	Read/Write	Note
154	General Inverter Alarm	---	0	1	R	Customer
155	Reserved - (not used or other special application or internal debug)	---	0	1	R	only for Service/Manufacturer
160	Air Filter Clogged (optional)	---	0	1	R	Customer
161	Alarm p-lan Unit1 (master) (optional)	---	0	1	R	Customer
162	Alarm p-lan Unit2 (slave) (optional)	---	0	1	R	Customer
163	Alarm p-lan Unit3 (slave) (optional)	---	0	1	R	Customer
164	Alarm p-lan Unit4 (slave) (optional)	---	0	1	R	Customer
165	Alarm p-lan Unit5 (slave) (optional)	---	0	1	R	Customer
166	Alarm p-lan Unit6 (slave) (optional)	---	0	1	R	Customer
167	Alarm p-lan Unit7 (slave) (optional)	---	0	1	R	Customer
168	Alarm p-lan Unit8 (slave) (optional)	---	0	1	R	Customer
169-171	Reserved - (not used or other special application or internal debug)	---	0	1	R	only for Service/Manufacturer
172	Fans Overload Alarm	---	0	1	R	Customer
173-174	Reserved - (not used or other special application or internal debug)	---	0	1	R	only for Service/Manufacturer
175	Remote Condenser Alarm (optional)	---	0	1	R	Customer

8 Troubleshooting

8.1 General

If there is a malfunction or alarm on the device, a corresponding error message will be displayed. The corresponding LED on the command panel will be illuminated and the alarm relay switched where applicable (collective fault signal).

Errors are divided into three categories.

1. **Alarms:** The device will be stopped (at least individual components).
2. **Warnings:** Selected device functions will no longer be executed.
3. **Messages:** A message is output on the display (for example, if a limit is exceeded) but the device remains operational.

- Press the "Alarm" button on the command panel to view all active error messages.
The location of the error and the component affected will be shown on the display.
- In the event of multiple errors, use the "Up" and "Down" buttons to scroll through the list.
- Press the "Alarm" button again to confirm the currently selected error.
Once the cause of the error has been rectified, the error message will be deleted from the list.



Note:

Following an automatic restart, the alarm LED and the corresponding message text will remain active until the "Alarm" button on the command panel has been pressed twice.

The following additional information about the error messages will be output at the end of the aforementioned list of error messages:

1. Sequence of error messages. "E01" is the oldest error, "E02" the one after that, and so on.
2. Date and time when the error occurred.
3. The alarm code, e.g. "ALF01".
4. A brief description of the cause of the error.
5. Inlet and outlet temperature and high and low pressure in the cooling circuit.



Note:

A maximum of 50 error messages will be saved. If further errors occur, the oldest error messages will be overwritten.



Note:

For technical queries, or if servicing is required, please contact Rittal using the addresses shown in section 18 "Customer service addresses".

8.2 Alarm relay circuit (general alarm)

Any error messages from the LCP DX which may occur may be output to an external signal source via a floating relay output. Depending on the connection to the X1A terminal strip, it is possible to determine whether the alarm should be switched as a normally closed or a normally open contact.

- Normally closed contact (NC): Connection clamp 101
- Normally open contact (NO): Connection clamp 102
- Shared conductor (C): Connection clamp 100



Note:

Further information on the precise connection points can be found in the circuit diagram for the LCP DX/FC supplied loose with the device.

8 Troubleshooting

8.3 List of error messages and solutions

Alarm code	Display	Possible cause	Possible solution
ALA02	Alarms ALA02 Position: B2 Probe B2 faulty or disconnected alarm	Sensor failure or sensor not correctly connected.	Check the connection on the motherboard or replace the sensor.
ALA03	Alarms ALA03 Position: B3 Probe B3 faulty or disconnected alarm	Sensor failure or sensor not correctly connected.	Check the connection on the motherboard or replace the sensor.
ALA04	Alarms ALA04 Position: B4 Probe B4 faulty or disconnected alarm	Sensor failure or sensor not correctly connected.	Check the connection on the motherboard or replace the sensor.
ALA06	Alarms ALA06 Position: B6 Probe B6 faulty or disconnected alarm	Sensor failure or sensor not correctly connected.	Check the connection on the motherboard or replace the sensor.
ALA07	Alarms ALA07 Position: B7 Probe B7 faulty or disconnected alarm	Sensor failure or sensor not correctly connected.	Check the connection on the motherboard or replace the sensor.
ALA08	Alarms ALA08 Position: B8 Probe B8 faulty or disconnected alarm	Sensor failure or sensor not correctly connected.	Check the connection on the motherboard or replace the sensor.
ALA09	Alarms ALA09 Position: B9 Probe B9 faulty or disconnected alarm	Sensor failure or sensor not correctly connected.	Check the connection on the motherboard or replace the sensor.
ALA10	Alarms ALA10 Position: B10 Probe B10 faulty or disconnected alarm	Sensor failure or sensor not correctly connected.	Check the connection on the motherboard or replace the sensor.
ALA11	Alarms ALA11 Position: B11 Probe B11 faulty or disconnected alarm	Sensor failure or sensor not correctly connected.	Check the connection on the motherboard or replace the sensor.
ALA12	Alarms ALA12 Position: B12 Probe B12 faulty or disconnected alarm	Sensor failure or sensor not correctly connected.	Check the connection on the motherboard or replace the sensor.
ALB01	Alarms ALB01 Position: ID3 High pressure	High ambient temperature, incorrect coolant filling, defective fan.	Check device limits, check coolant volume and check correct functioning of fan.
ALB02	Alarms ALB02 High pressure compressor 1 by transducer	High ambient temperature, incorrect coolant filling, defective fan.	Check device limits, check coolant volume and check correct functioning of fan.
ALB03	Alarms ALB03 Low pressure compressor/compressors by transducer	Incorrect coolant filling, insufficient quantity of coolant, blocked coolant lines, thermostatic valve closed.	Check coolant volume, check lines for leaks, check thermostatic valve.

8 Troubleshooting

Alarm code	Display	Possible cause	Possible solution
ALC01	Alarms ALC01 Position: ID2 Compressor 1 overload or inverter alarm	High inlet temperature, high heat load, incorrect pipework, incorrect wiring.	Check operating conditions as per compressor specifications, check device limits, check pipework and wiring.
ALC03	Alarms ALC03 Envelope alarm zone	Operating conditions outside of compressor specifications.	Check operating conditions as per compressor specifications.
ALC04	Alarms ALC04 Compressor start failure (temp./max.)	Inadequate pressure difference during device startup, excess current or missing phase on inverter, blocked inverter.	Check operating conditions as per compressor specifications, check device limits, check error codes in inverter manual.
ALC05	Alarms ALC05 High discharge gas temperature	High inlet temperature, high heat load, incorrect pipework.	Check operating conditions as per compressor specifications, check device limits, check pipework.
ALC06	Alarms ALC06 Low pressure differential (insuff. lubrication)	Operating conditions outside of compressor specifications or device limits, blocked compressor, incorrect wiring.	Check operating conditions as per compressor specifications, check device limits, check wiring.
ALF01	Alarms ALF01 Position: ID1 Fan overload	Incorrect wiring.	Check wiring against circuit diagram.
ALD02	Alarms ALD02 Probe S1: Probe S2: Probe S3: Probe S4:	Sensor failure or sensor not correctly connected.	Check the connection on the motherboard or replace the sensor.
ALD03	Alarms ALD03 EEV motor error	Incorrect or missing wiring between motherboard and valve motor.	Check the connection on the motherboard or replace on the valve motor.
ALD04	Alarms ALD04 Low superheat (LowSH)	Incorrect coolant filling, insufficient heat load, insufficient fan speed.	Check device limits, check coolant volume, check fan speed.
ALD05	Alarms ALD05 Low suction temperature	Cf. ALD04 and ALD06.	Cf. ALD04 and ALD06.
ALD06	Alarms ALD06 Low evaporation temperature (LOP)	Incorrect coolant filling, insufficient coolant volume, blocked coolant lines, thermostatic valve closed.	Check coolant volume, check lines for leaks, check thermostatic valve.
ALD07	Alarms ALD07 High evaporation temperature (HOP)	High inlet temperature, incorrect PID valve parameter.	Check valve PID parameters, alarm delay, raise the MOP limit (max. 25°C) if condenser ambient temperature is max. 35°C.
ALD08	Alarms ALD08 High condensing temperature (HiTcond)	High ambient temperature, incorrect coolant filling, defective fan on condenser.	Check device limits, check coolant volume, check fan on condenser.
ALD09	Alarms ALD09 Driver offline	Cf. inverter manual.	Cf. inverter manual.
ALL01	Alarms ALL01 Power+ offline	Wrong communication between the driver and the motherboard.	Check the MODbus connection cable; check the communication parameters.

8 Troubleshooting

Alarm code	Display	Possible cause	Possible solution
ALL02	Alarms ALL02 Power+ Generic Alarm	Over or under current; over or under voltage; over or under temperature of the drive of the compressor motor; see drive manual "code [105]".	Check the cable; check previous high pressure alarm.
ALL99	99 Unexpected inverter stop	Short power failure.	Restart the unit; connect to a UPS if necessary. After the reset, the alarm is stored in the alarm data log as ALL01.
ALW04	ALW04 Max temperature (warning)	A previous alarm has stopped the unit; heat load too high compared to the cooling capacity of the unit.	Reset the previous alarm.

9 Inspection and maintenance

The following maintenance work should be carried out on the LCP DX:

- The condensate water discharge device should be checked regularly for correct functioning.
- Regularly check the coolant circuit and all main components for correct functioning (at least once a year according to DIN EN 378).
- Regularly check for leaks using a suitable device (annually) as required by the F-gas regulation (see section 2.3.3 "F-gas regulation" and section 2.3.4 "Chemicals – Climate Protection Ordinance").
- Every two months: Check the pressure in the cooling water circuit (LCP DX/FC only)

9.1 Safety instructions concerning maintenance work

- Ensure that the personnel carrying out essential maintenance work wears the required personal safety equipment (see section 2.2.1 "Personal safety equipment").
- For all maintenance work, please ensure that the LCP DX is switched off completely at the master switch and secured against re-activation.

9.2 Cleaning the heat exchanger

During regular checks of the device, if you ascertain any dirt in the heat exchanger it must be cleaned.

- Use compressed air or a vacuum cleaner with the brush attachment to clean the heat exchanger.

9.3 Fan replacement



Caution! Risk of injury!
Before installing or removing a fan, be sure to de-energise the relevant fan on the corresponding switch.



Note:
At an ambient temperature of 40°C, the nominal service life of the built-in fan is 40,000 operating hours.

If a fan module is defective, it can be replaced quickly and easily with the unit operational.

Proceed as follows to remove a fan module:

- Open the front door of the LCP DX.
- On the left side of the LCP DX frame at the rear, deactivate the switch for the fan you wish to replace.

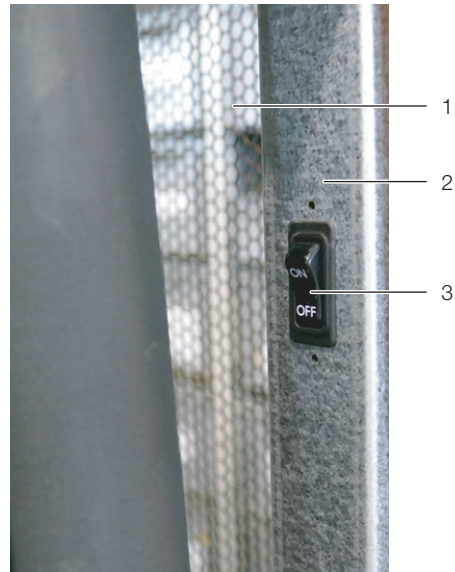

Fig. 46: Switch for activating/deactivating a fan

Key

- 1 Front door
- 2 Rear of frame
- 3 Switch

- Release the two DC and AC fan connectors on the left and right (fig. 47, items 2 and 3).
- Loosen the two assembly screws, right and left, at the top and bottom of the fan.



Fig. 47: Fan module

Key

- 1 Assembly screws (4 x)
- 2 DC connection cable (control voltage)
- 3 AC connection cable (power supply)
- 4 Fan
- 5 Air baffle plate

- Grasp the fan with both hands on the left and right, and pull it out of the rack.



Note:
The LCP DX may only be operated with all three fans running.

9 Inspection and maintenance

9.4 Check the cooling water circuit (LCP DX/FC only)

At regular intervals (at least every 2 months), the pressure in the cooling water circuit should be checked on the corresponding manometer.



Fig. 48: Manometer in the water circuit

Key

1 Manometer

- Switch off the cooling water circuit so that the cooling water pump no longer runs.
The needle on the manometer must show a value above the red setting.

10 Storage and disposal



Caution! Risk of damage!

The LCP DX must not be subjected to temperatures above +50°C during storage.

During storage, the LCP DX must stand upright.
Disposal can be performed at the Rittal plant.
Please contact us for advice.



Caution! Risk of environmental contamination!

Never allow refrigerant from the cooling circuit or oil from the compressor to escape into the environment.

Refrigerant and oil must be properly disposed of in accordance with the valid national legislation and regulations.



Caution! Risk of environmental contamination!

Cooling water from the circuit must not be added to the wastewater circuit. The cooling water must be properly disposed of in accordance with the valid national legislation and regulations.

11 Technical specifications

11 Technical specifications

11.1 TopTherm LCP Inline DX

Technical specifications		
Description/Model No.	TopTherm LCP Inline DX / 3311.450 (1000 mm depth)	
Description/Model No.	TopTherm LCP Inline DX / 3311.470 (1200 mm depth)	
Dimensions and weight		
Dimensions width x height x depth [mm]	600 x 2000 x 1000 (3311.450)	
Dimensions width x height x depth [mm]	600 x 2000 x 1200 (3311.470)	
U height	42	
Weight, max. [kg]	398 (including all options)	
Electrical connection		
Type of electrical connection	Connection clamp	
Rated voltage [V, Hz]	380...480 V ±10 %, 3~, N, PE, 50/60 Hz	
Rated current [A]	22.4	
Startup current [A]	32	
Pre-fuse T [A]	40 (standard) 50 (including all options)	
Duty cycle [%]	100	
Cooling output		
Nominal cooling capacity EN 14511 [kW]	[L35/L35]: 35	[L35/L35]: 35
	[L35/L45]: 28	[L35/L45]: 35
Total power input [kW]	[L35/L35]: 14	[L35/L35]: 14
Energy Efficiency Ratio (EER) L35 L35	2.5	
Air throughput, max. [m ³ /h]	9892	
Coolant circuit		
Coolant/Fill volume [kg]	R410A/see tab. 22 "Coolant fill volume"	
Max. allowable pressure [bar]	HP 42/LP 30	
Connection diameter refrigerant pipes [mm]	See tab. 23 "Refrigerant pipes"	
External diameter of coolant lines [mm]	See tab. 23 "Refrigerant pipes" (1 mm wall thickness)	
Other information		
Noise level [dB(A)]	68	
Storage temperatures [°C]	-20...+50	
Temperature range [°C]	+5...+35	
IP protection category IEC 60529	IP 20 (indoor)	
Colour	RAL 7035	

Tab. 17: Technical specifications LCP DX

11.2 TopTherm LCP Inline DX/FC

Technical specifications		
Description/Model No.	TopTherm LCP Inline DX/FC / 3311.460 (1000 mm depth)	
Description/Model No.	TopTherm LCP Inline DX/FC / 3311.480 (1200 mm depth)	
Dimensions and weight		
Dimensions width x height x depth [mm]	600 x 2000 x 1000 (3311.460)	
Dimensions width x height x depth [mm]	600 x 2000 x 1200 (3311.480)	
U height	42	
Weight, max. [kg]	398 (including all options)	
Electrical connection		
Type of electrical connection	Connection clamp	
Rated voltage [V, Hz]	400 (3~/N/PE), 50	380...460 (3~/N/PE), 60
Rated current [A]	31.6	31.6
Startup current [A]	32	32
Pre-fuse T [A]	50	50
Duty cycle [%]	100	
Cooling output		
Nominal cooling capacity EN 14511 [kW]	[L35/L35]: 35	[L35/L35]: 35
	[L35/L45]: 28	[L35/L45]: 35
Total power input [kW]	[L35/L35]: 19	[L35/L35]: 19
Energy Efficiency Ratio (EER) L35 L35	1.84	
Air throughput, max. [m ³ /h]	9892	
Coolant circuit (DX)		
Coolant/Fill volume [kg]	R410A/see tab. 22 "Coolant fill volume"	
Max. allowable pressure [bar]	HP 42/LP 30	
Connection diameter refrigerant pipes [mm]	See tab. 23 "Refrigerant pipes"	
External diameter of coolant lines [mm]	See tab. 23 "Refrigerant pipes" (1 mm wall thickness)	
Cooling water cycle (CW)		
Cooling medium/fill volume of heat exchanger [l]	Water/glycol mixture/8.4	
Max. proportion of ethylene glycol [%]	40	
Pressure loss of heat exchanger [bar]	0.9 (at 30% glycol)	
Connection of cooling water lines	1½" external thread	
Other information		
Noise level [dB(A)]	68	
Storage temperatures [°C]	-20...+50	
Temperature range [°C]	+5...+35	

Tab. 18: Technical specifications LCP DX/FC

11 Technical specifications

Technical specifications	
IP protection category IEC 60529	IP 20 (indoor)
Colour	RAL 7035

Tab. 18: Technical specifications LCP DX/FC

11.3 Standard condenser unit

Technical specifications	
Description/Model No.	Standard condenser unit / 3311.370
Dimensions and weight	
Dimensions W x H x D ("H" version) [mm]	2219 x 1099 x 850
Dimensions W x H x D ("V" version) [mm]	2206 x 830 x 570
Weight, max. [kg]	210
Electrical connection	
Type of electrical connection	Connection clamp
Rated voltage [V, Hz]	230 (1~/N/PE), 50/60
Startup current [A]	5.24
Pre-fuse T [A]	6
Duty cycle [%]	100
Coolant circuit (DX)	
Coolant/Fill volume [kg]	R410A/see tab. 22 "Coolant fill volume"
Connection diameter refrigerant pipes [mm]	See tab. 23 "Refrigerant pipes"
External diameter of coolant lines [mm]	See tab. 23 "Refrigerant pipes" (1 mm wall thickness)
Other information	
Storage temperatures [°C]	-20...+50
Temperature range [°C]	-20...+45
Noise level [dB(A)] (Open air above reflective flooring, distance 10 m)	40
Noise level [dB(A)] (Open air above reflective flooring)	71

Tab. 19: Technical specifications for the standard condenser unit

11.4 Condenser unit for indirect free cooling

Technical specifications	
Description/Model No.	Condenser unit for indirect free cooling / 3311.380
Dimensions and weight	
Dimensions W x H x D ("H" version) [mm]	3048 x 1270 x 1110
Dimensions W x H x D ("V" version) [mm]	2803 x 1040 x 705
Weight, max. [kg]	285
Electrical connection	
Type of electrical connection	Connection clamp
Rated voltage [V, Hz]	400 (3~/N/PE), 50 460 (3~/N/PE), 60
Startup current [A]	7
Pre-fuse T [A]	8
Duty cycle [%]	100
Coolant circuit (DX)	
Coolant/Fill volume [kg]	R410A/see tab. 22 "Coolant fill volume"
Connection diameter refrigerant pipes [mm]	See tab. 23 "Refrigerant pipes"
External diameter of coolant lines [mm]	See tab. 23 "Refrigerant pipes" (1 mm wall thickness)
Cooling water cycle (CW)	
Cooling medium/fill volume of heat exchanger [l]	Water/glycol mixture/14
Max. proportion of ethylene glycol [%]	40
Pressure loss of heat exchanger [bar]	0.4 (at 30% glycol)
Connection of cooling water lines	1½" external thread
Other information	
Storage temperatures [°C]	-20...+50
Temperature range [°C]	-20...+45
Noise level [dB(A)] (Open air above reflective flooring)	87

Tab. 20: Technical specifications for the condenser unit for indirect free cooling

11 Technical specifications

11.5 High temperature condenser

Technical specifications	
Description/Model No.	High temperature condenser unit / 3311.XXX
Dimensions and weight	
Dimensions W x H x D ("H" version) [mm]	3222 x 1099 x 850
Dimensions W x H x D ("V" version) [mm]	3206 x 830 x 570
Weight, max. [kg]	146
Electrical connection	
Type of electrical connection	Connection clamp
Rated voltage [V, Hz]	230/1~/N/PE, 50
Startup current [A]	2,91
Pre-fuse T [A]	2,91
Duty cycle [%]	100
Cooling circuit	
Coolant/Fill volume [kg]	R410A/see tab. 22 "Coolant fill volume"
Connection diameter refrigerant pipes [mm]	See tab. 23 "Refrigerant pipes"
External diameter of coolant lines [mm]	See tab. 23 "Refrigerant pipes" (1 mm wall thickness)
Other information	
Storage temperatures [°C]	-20...+50
Ambient temperature [°C]	-20...+55
Noise level [dB(A)] (Open air above reflective flooring, distance 10 m)	41

Tab. 21: Technical specifications for the high temperature condenser unit

11.6 Coolant fill volume

System: LCP DX + condenser	Fill volume up to a line length of 5 m [kg]	Fill volume per metre above 5 m [kg]
System with standard condenser	8.0	0.1
System with condenser for indirect free cooling	9.8	0.1
System with high temperature condenser	8.6	0.1

Tab. 22: Coolant fill volume

11.7 Refrigerant pipes

Connection diameter LCP DX 35 kW: 16 mm/16 mm

Type of condenser	Connection diameter condenser liquid line/hot gas line [mm]	Equivalent length	External diameter of coolant lines liquid line/hot gas line [mm]
Standard	28/28	Up to 10 m	16/16
		10 m to 30 m	16/18
		30 m to 45 m	16/22
		45 m to 60 m	18/22
High temperature	28/28	Up to 10 m	16/16
		10 m to 30 m	16/18
		30 m to 45 m	16/22
		45 m to 60 m	18/22
Hybrid DX Free cooling	28/35 2"/2"	Up to 10 m	16/16 – 1½/1½
		10 m to 30 m	16/18 – 1½/1½
		30 m to 45 m	16/22 – 1½/1½
		45 m to 60 m	18/22 – 1½/1½

Tab. 23: Refrigerant pipes

12 Spare parts

12 Spare parts

Article	Qty./Pack
Control unit	1
Display	1
Compressor	1
Inverter	1
Electronic expansion valve	1
Fan, single	1
Switch for fan	1
High-pressure switch	1
Temperature sensor hot/cold air	1
Coolant filter	1

Tab. 24: Spare parts list – LCP DX

13 Accessories

Article	Model No.	Qty./Pack	Remarks
Standard condenser	3311.370	1	Required for operation of the LCP DX.
Condenser for indirect free cooling	3311.380	1	Required for operation of the LCP DX/FC.
Vertical shielding (foam strips) for enclosure width 600 mm, for external mounting on side panel	3301.380	1	
Vertical shielding (foam strips) for enclosure width 600 mm, for external mounting on LCP DX	3301.370	1	
Vertical shielding (foam strips) for enclosure width 800 mm, for external mounting on side panel	3301.390	1	
Vertical shielding (foam strips) for enclosure width 800 mm, for external mounting on LCP DX	3301.320	1	
Air baffle plate for TS, for enclosure width 600 mm	7151.206	2	
Air baffle plate for TS, for enclosure width 800 mm	7151.208	2	
Add-on cover	3301.221	1	
Server enclosure compensating panel for LCP Inline DX	7067.200	1	

Tab. 25: Accessories list – LCP DX

14 SNMP card

To incorporate the device into a building management system, a pCO Web card is installed in the electronics box.

Then the LCP DX website provides all essential information on the homepage. For example, it depicts a collective alarm. The name and location of the LCP DX may also be configured on this website. A second operating level allows you to set the server air injection temperature.

Logging on to the LCP DX website

- Open the browser and enter the IP address of the LCP DX (or the pCO Web card) in the address line. Example of a static IP address:
http://172.16.0.1
- A dialogue will appear for logging onto the LCP DX.
- Enter **rittal** as the user and **1234** as the password. The LCP DX website will appear.

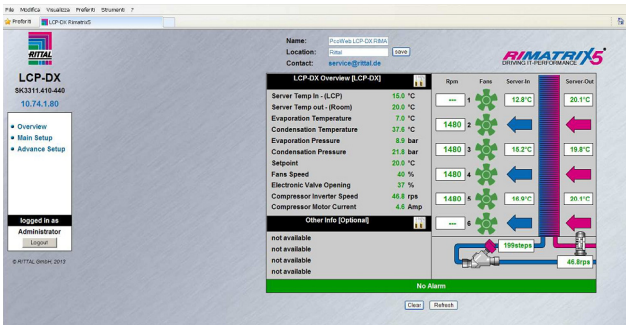

Fig. 49: LCP DX homepage

The following parameters are displayed in tabular form on the LCP DX homepage.

- Server Temp In (average)
- Server Temp Out (average)
- Evaporation Temperature
- Condensation Temperature
- Evaporation Pressure
- Condensation Pressure
- Setpoint
- Fans Speed
- Electronic Valve Opening
- Compressor Inverter Speed
- Compressor Motor Current

The following parameters are displayed in diagrammatic form on the LCP DX homepage.

- Setpoint speed for the fans
- Server-in temperature (top, middle, bottom)
- Server-out temperature (top, middle, bottom)
- Position of the electronic expansion valve
- Compressor speed

The 2nd menu level, **Main Setup**, is password-protected. The server air injection temperature of the LCP DX may be set here.

- Click on the **Main Setup** entry in the left-hand section of the website. Alternatively, click on the stylised Allen key in the central section of the website, under **LCP-DX Overview**. A further dialogue will appear for authentication.

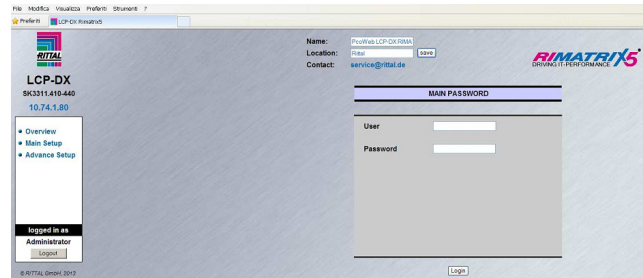

Fig. 50: Logging on to the 2nd menu level (Main Setup)

- Once again, enter **rittal** as the user and **1234** as the password. The following screen will appear:

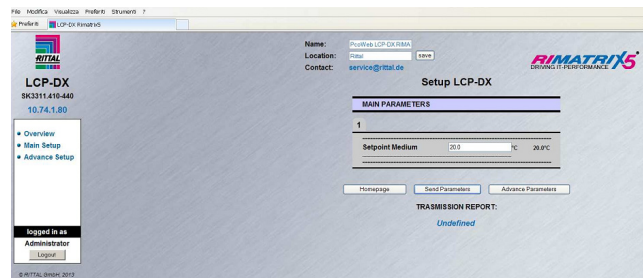

Fig. 51: Setting the server air injection temperature

- Set the server air injection temperature to the required value between 7°C and 25°C.
- Confirm your entry by clicking on the **Send Parameters** button.
- Clicking on the **Homepage** button will take you back to the LCP DX homepage.

15 Options

15.1 General information

All models of the LCP DX series can be equipped with the following options:

1. Humidifier
2. Electrical heaters
3. Dehumidification function
4. Condensate pump
5. Condenser unit for high ambient temperatures
6. Air filter with clogged filter alarm
7. Redundancy



Note:
When the "Dehumidification function" (option 3) is selected, also the "Electric heater" (option 2) must be selected.

15.2 Humidifier

15.2.1 General information

If the ambient air at the installation location of the LCP DX has a very low humidity, there is the danger of device damage caused by electrostatic charges.

The "Humidifier" option allows the humidity to be increased at the installation location. The option consists of two components:

- Immersed electrodes humidifier for producing the extremely small droplets (approx. 1...5 µm diameter)
- Distribution pipe behind the evaporator for distributing the droplets into the air flow

A humidity sensor is also installed on the inlet side of the LCP DX. The value acquired here is compared with the setpoint for the humidity and the humidifier is activated only when required.



Note:
When in use, the humidifier performs an automatic flushing operation every 60 minutes. When the humidifier is in standby mode, the flushing operation is performed once every 24 hours.

15.2.2 Activating the humidifier

To activate the humidification function, proceed as follows:

- Assign the "YES" value to the "Enable B5 humidity" entry in the "Hc39" menu.

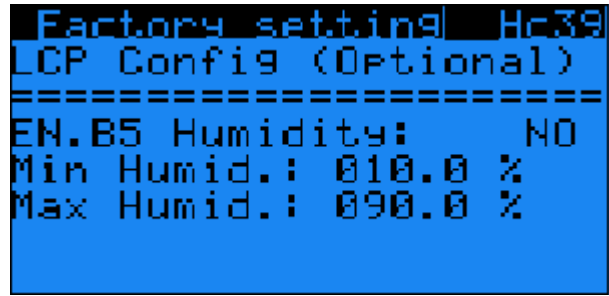

Fig. 52: "Hc39" menu

- Also assign the "YES" value to "Enable" entry in the "Ha35" menu.

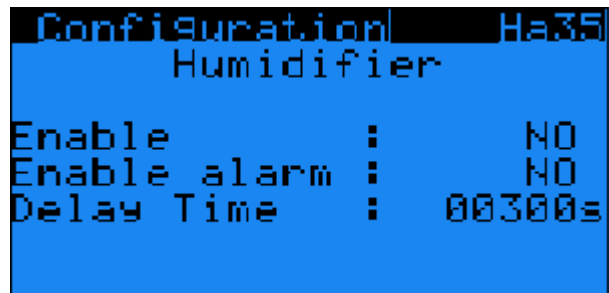

Fig. 53: "Ha35" menu

15.2.3 Setting the humidity setpoint

In order to set the required target humidity, please proceed as follows:

- Switch to the menu "Hc85" and ascribe the required value to the "Set Point" entry (e.g. 55.0%)

15.2.4 Technical specifications

Technical specifications	
Creation of atomised water (capacity)	5...8 kg/h
Power supply	400...460 V/3~/50/60 Hz
Current consumption	8.7 A/7.5 A
Power consumption	3.75...6 kW
Water supply temperature range	1...40°C
Water supply pressure range	1...8 bar
Water supply flow rate	0.6 l/min
Water supply	Tap water (≤ 400 ppm)
Discharge flow	4 l/min
Water discharge temperature	up to 100°C

Tab. 26: Humidifier technical specifications



Note:

Drinking water can also be used for operating the humidifier.

- If the humidifier is connected directly to the drinking water system, the technical regulations for protecting the drinking water must be observed.
- The water used to operate the humidifier must comply with the requirements of VDI 2035.
- If the humidifier is used together with a condensate pump, failure to observe the VDI 2035 specifications can cause the condensate pump to malfunction.
- Rittal recommends that the device is operated with demineralised water as the service life of the humidifier may otherwise be adversely affected, depending on the quality of the drinking water.

15.2.5 Installation prerequisites



Note:

The humidifier can also be installed subsequently in a previously installed LCP DX. In this case, contact Rittal Service (see section 18 "Customer service addresses").

The water is supplied to the humidifier from a hose already installed at the factory (connection diameter 3/4" external thread).

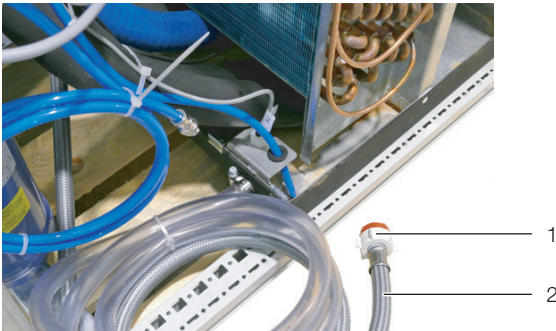

Fig. 54: Connection hose with 3/4" external thread adapter

Legend

- 1 3/4" external thread adapter
- 2 Connection hose

The humidifier discharge is made into the condensate collection tray.

- Ensure that the condensate discharge is installed correctly (see section 6.4 "Connecting the condensate discharge").
- Alternatively, connect the optional condensate pump (see section 15.5 "Condensate pump").

15.3 Electrical heaters

15.3.1 General information

This option is particularly suitable

- for low ambient temperatures at the installation location of the IT cabinet, or
- for low thermal loads such as those which occur typically during the first phase after the installation.

The electrical heaters guarantee a constant supply air temperature to the installed devices even for such application cases.

This option must also be installed when the "Dehumidification" option is used (see section 15.4 "Dehumidification").

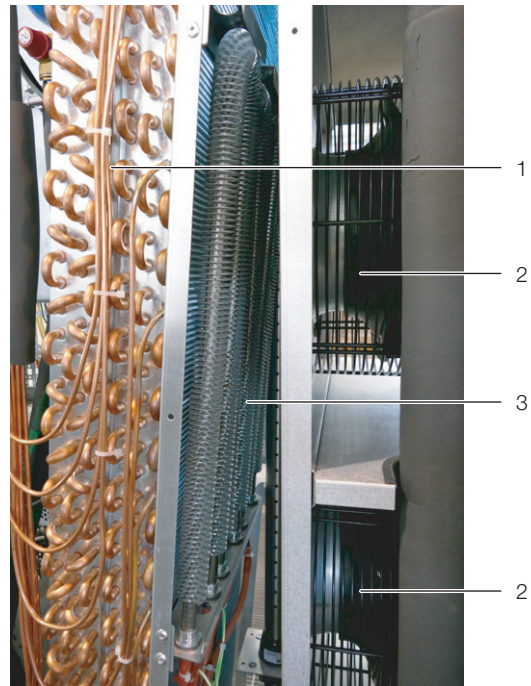

Fig. 55: Electrical heaters

Key

- 1 Evaporator coil
- 2 Fan
- 3 Heater

Viewed from the front of the device, the heater is behind the fans and in front of the evaporator coil.

The heaters are switched on automatically by the LCP DX controller when the average value of the air temperature falls below a specified setpoint.

In case of "Room" operating mode, the air temperature is the return air from the servers, while for "Row" operating mode, the air temperature is the supply air to the servers.

15.3.2 Activating the heaters

To activate the heaters, proceed as follows:

- Assign the "YES" value to the "Resistance present" entry in the "Ha25" menu.

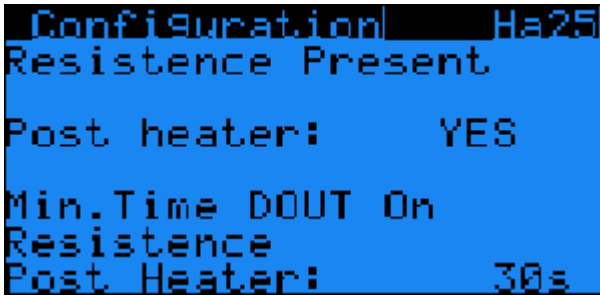

Fig. 56: "Ha25" menu

In order to reduce the heaters ON-OFF and stabilise as much as possible the air temperature, the electric heaters will be switched on at (set-point – Diff ON) and switched off at (set-point – Diff ON + Diff OFF): Diff ON and Diff OFF parameters can be set in the mask Gfc30.

- Set the desired values for the "Diff ON" and "Diff OFF" parameters in the "Gfc30" menu.

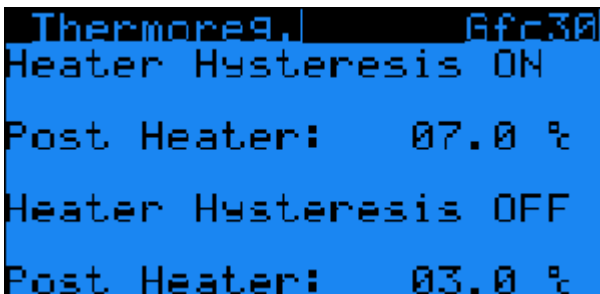

Fig. 57: "Gfc30" menu

The thermo-fuses for the heaters are situated in a separate electronics box installed at the top front of the LCP DX, above the fans.

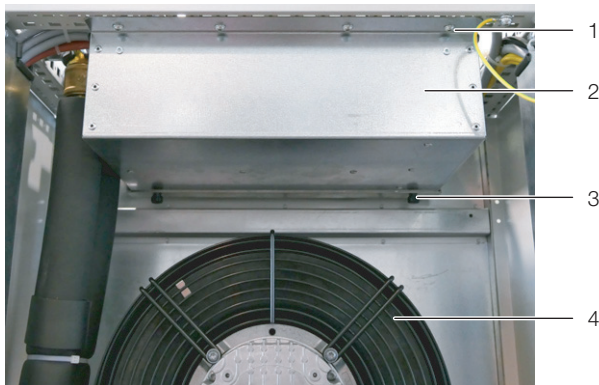

Fig. 58: Additional electronics box

Key

- 1 Assembly screws, bottom (4 x)
- 2 Electronics box
- 3 Assembly screws, bottom (2 x)
- 4 Fan

15.3.3 Technical specifications

Technical specifications	
Power supply	1-phase 230 VAC / 50...60 Hz

Tab. 27: Technical specifications of the electrical heaters

Technical specifications	
Current consumption	9 A
Power consumption	6 kW (3 heaters each with 2 kW)

Tab. 27: Technical specifications of the electrical heaters

15.4 Dehumidification

15.4.1 General information

At installation locations where high humidity generally prevails, there is the danger that water condenses inside the IT cabinet. This can cause short-circuits and other damage to the installed devices. Excessive humidity can also lead to rust and corrosion.

To prevent this, the LCP DX can be equipped with a dehumidification function, whereby a humidity sensor is mounted on the inlet side of the device and a temperature sensor is mounted behind the evaporator. The "Electrical heaters" option must also be installed (see section 15.3 "Electrical heaters").

15.4.2 Activating the dehumidification

To activate the heaters, proceed as follows:

- Assign the "YES" value to the "Enable" entry in the "Ha30" menu.

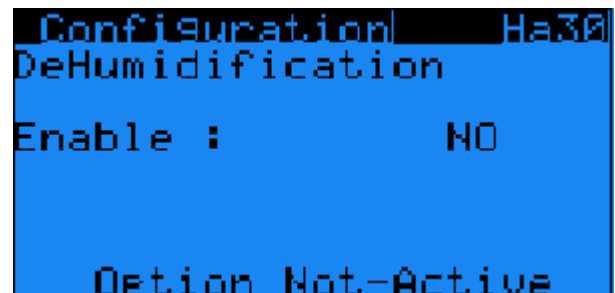

Fig. 59: "Ha30" menu

- Set the setpoint for the humidity in the "B03" menu.

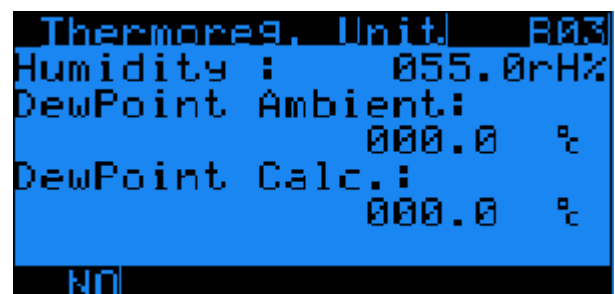

Fig. 60: "B03" menu

- Also activate the electrical heaters (see section 15.3.2 "Activating the heaters").

If the value measured by the humidity sensor is higher than the above-mentioned setpoint, the dehumidification will be activated automatically:

- The compressor is activated to provide condensation at the evaporator.

15 Options

– The electrical heaters are deactivated only when the air temperature is higher than the specified setpoint (see section 15.3 "Electrical heaters").

When the return air humidity reaches the set-point, dehumidification function is again turned off.

In order to better reach the target of humidity set-point, it is possible to set periods of "dehumidification ON" and "dehumidification OFF" in the mask B05, in case the server room conditions and the required humidity set-point are particularly critical.

■ Assign the desired activation and deactivation times to the "dehumidification ON" and "dehumidification OFF" entries in the "B05" menu, respectively.

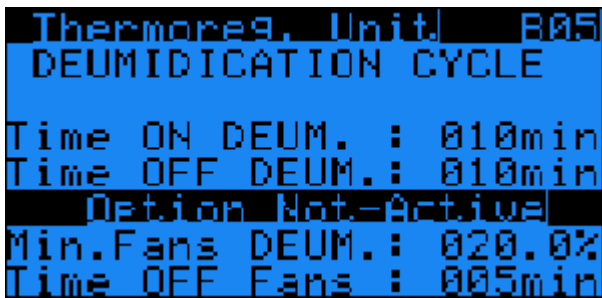

Fig. 61: "B05" menu

15.4.3 Installation prerequisites

Any condensate that occurs is then fed to the condensation tray.

■ Ensure that the condensate discharge is installed correctly (see section 6.4 "Connecting the condensate discharge").

■ Alternatively, connect the optional condensate pump (see section 15.5 "Condensate pump").

15.5 Condensate pump

15.5.1 General information

If the condensate or water from the humidifier cannot be discharged by gravity from the condensation tray, a condensate pump should be installed. This condensate pump is activated automatically by the LCP DX controller when a level sensor reports the appropriate filling level in the condensation tray.



Note:

The condensate discharge from the condensate pump must not lead directly into the drainage system without first passing through an odour trap. The condensate pump is not a guarantee against blockages or emerging waste water under backpressure.

15.5.2 Technical specifications

Technical specifications	
Power supply	1-phase 230 VAC / 50...60 Hz
Current consumption	0.1 A
Power consumption	10 W

Tab. 28: Technical specifications for the condensate pump

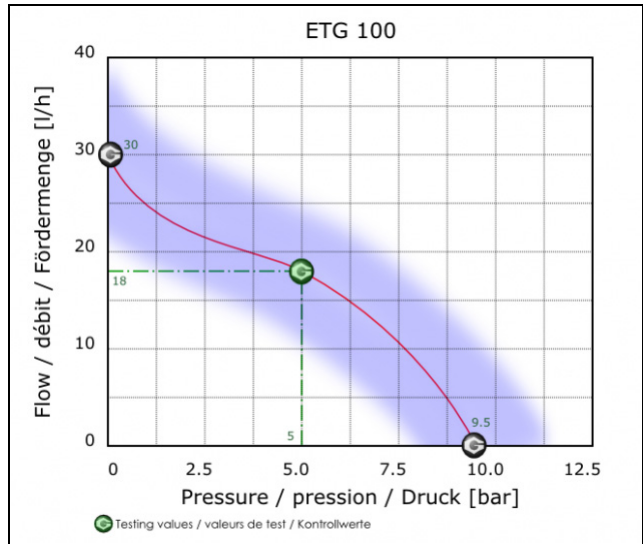

Fig. 62: Power diagram for the condensate pump

15.5.3 Installation

■ Connect the pump pipe connection (diameter 1/8" M") with an external pipe to discharge the water of the tray.



Fig. 63: Connections of the condensate pump

Key

- 1 Condensate collecting tray
- 2 Intake hose condensate pump
- 3 Discharge hose condensate pump

15.6 High temperature condenser

15.6.1 General information

As standard, the condenser unit of the LCP DX can be operated at outdoor temperatures as high as +45 °C. If this maximum temperature is overshoot (to maximum +53°C), the optional high temperature condenser that replaces the 3311.370 standard unit must be deployed.

For the above-mentioned maximum temperature, the maximum cooling capacity with the optional condenser is 28 kW.

15.6.2 Installation prerequisites

Note the larger dimensions of the high temperature condenser compared with the 3311.370 standard unit (fig. 74).

 **Note:**
When this option is used, the filling volume of the refrigerant increases to 8.6 kg (rather than 8.0 kg).

15.7 Air filter

15.7.1 General information

The LCP DX can be equipped with an air filter of the class G3 that prevents contamination, in particular for the evaporator, such as by dust in the air flow. In addition to the air filter, installed in both rear doors, a differential pressure sensor measures the pressure loss through the filter. If this value exceeds the specified threshold, an appropriate warning will be issued. The filter should then be cleaned.

Because the LCP DX can operate with air flows of different strengths, different pressure losses at the filter can result. Therefore, the above-mentioned threshold for the warning message for the associated installation of the LCP DX must be customised accordingly. Otherwise, no warning message will ever be issued for a threshold that is too high, conversely, warning messages will be issued continually for a threshold that is too low.

The following table provides a guide for appropriate setting values.

Fan speed	Setting value
30%	20 Pa
50%	60 Pa
75%	100 Pa
100%	180 Pa

Tab. 29: Assignment of the fan speed to the setting value

15.7.2 Setting the threshold

- Set the threshold appropriate for the air flow directly at the adjustment screw of the differential pressure sensor (see table 29).



Fig. 64: Adjustment screw at the differential pressure sensor

- Assign the "YES" value to the "Alarm clogged filter" entry in the "Ha20" menu to activate the warning message.

15.7.3 Maintenance

- Always wear the required personal safety equipment when carrying out maintenance work on the air filter (see section 2.2.1 "Personal safety equipment").
- Based on an appropriate and correct setting for the threshold: Clean the air filter with compressed air when a warning message occurs and in regular intervals.
- To do this, blow compressed air against the air-flow direction in the installed state.

15.8 Redundancy

15.8.1 General information

If more than one LCP DX is installed in the same installation room, they can work independently of each other or together.

No customizations are required for individual control of the devices. The devices can be operated with different parameters and setting values.

In case of Teamwork, the devices can be programmed as follows:

- **Alarm:** If one working unit is in alarm, one of the stand-by LCP-DX automatically starts.
- **Time-based rotation:** After a preset time, one of the running stops and is replaced by one of the stand-by.
- **Missing cooling capacity:** If the required cooling capacity is not achieved with the running devices, additional devices will be started automatically.

15.8.2 Installation

- Connect the operating and display elements for a maximum of eight LCP DXs using a twin-core cable. The X5 connector is located at the bottom of the electronics box, in the rear section of the unit.
- Note that the maximum cable length from the first LCP DX to the last LCP DX must not exceed 100 m.

15.8.3 Activating the redundancy

- Assign the "YES" value to the "Enable rotation" entry to all LCP DX devices of the group in the "Ha11" menu.

15 Options

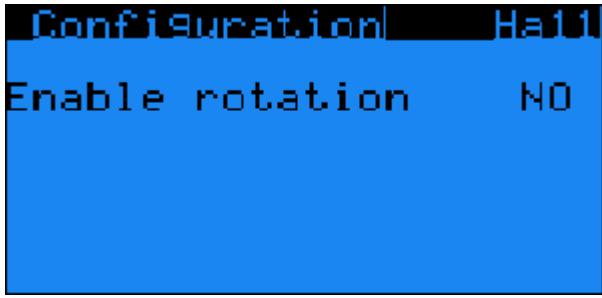

Fig. 65: "Ha11" menu

The following settings are displayed in the "Ha12" menu on the master unit that controls the complete group.

Parameter	Explanation
Devices Number	Number of LCP DX devices in the group.
Min. Devices Number	Minimum number of LCP DX devices of the group that are always activated.
Sel. Probes Regulation	"Average Probes": The closed-loop control is made with the average value of all activated devices of the group. "Master": The closed-loop control is made with the master unit.
Rotation Time	Time after which one device is switched off and another device is started automatically.

Tab. 30: Settings in the Ha12 menu

If only two LCP DX devices are connected to form a group for which one device is activated and one device is in stand-by:

- **Always** assign the "Average" value to the "Sel. Probe Regulation" entry in the "Ha12" menu.

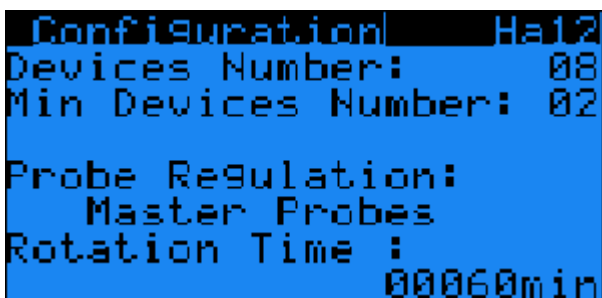

Fig. 66: "Ha12" menu

When the redundancy for missing cooling capacity is provided, a temperature band for all LCP DX devices of the group is split up which are activated closer the temperature is to the set-point + band.

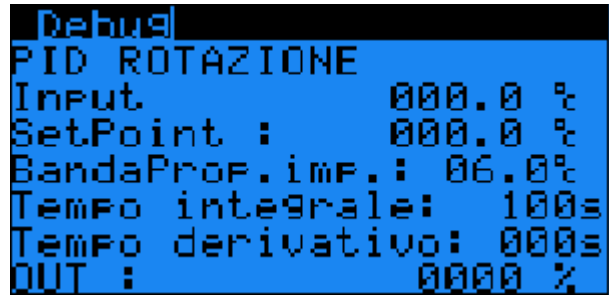

Fig. 67: "Debug" menu

15.8.4 Installation prerequisites

No additional software is required for redundancy operation. For previously installed devices, it must be guaranteed that the correct version of the software is present.

16 Further technical information

16.1 Coolant information



Caution!

The LCP DX may only be operated with coolant R410A. Use of any other coolant will invalidate the guarantee.



Caution! Risk of malfunction or damage! Installation, and in particular the coolant line pipework between the external condenser and the LCP DX, must only be carried out by trained, qualified and accredited cooling system specialists.

To avoid damage to the device, Rittal prescribes the use of coolant R410A.

R410A is virtually azeotropic and is comprised of equal parts of R32 and R125. The basic properties of R410A are:

- No ozone depletion potential
- Clear
- Liquefied gas smelling of ether
- Non-combustible
- Low toxicity

Property	Value
Composition	50%: R32 (CH ₂ F ₂) 50%: R125 (C ₂ HF ₅)
Molar mass [g/mol]	72.585
Boiling point [°C]	-52.7
Vapour pressure [bar]	12.46 at 15°C
Relative density	1.11 at 15°C

Tab. 31: Material data for R410A



Note:

Safety data sheets are available as downloads on www.rittal.com.

16.2 Information about cooling water (LCP DX/FC only)

To avoid damages to the system and ensure reliable operation, the provisions of VDI 2035 should be observed for filling and top-up water.

Admissible cooling media

- Saline and low-salinity water based on VDI 2035 plus max. 50 volume percent Antifrogen-N (see table 32).

Recommended cooling medium

- Low-salinity water (demineralised water) based on VDI 2035. Up to a maximum of 50 volume percent Antifrogen-N may be added (see table 32).

	Low-salinity	Saline
Electrical conductivity at 25°C [µS/cm]	< 100	100...1,500
Appearance	Free from sedimenting substances	
pH value at 25°C	8.2...10.0	
Oxygen [mg/l]	< 0.1	< 0.02

Tab. 32: Water specifications

16.3 Cooling output

16.3.1 General

Due to the device configuration comprising two sub-units, and the partially linear operation of the components (fan, inverter-controlled compressor), the cooling output of the device is dependent on various factors:

- External temperature at the installation site of the external condenser
- Heat loss from the server enclosure
- Inlet temperature of hot air into the LCP DX
- Settings

The charts and tables apply to the following operating data:

- Exterior temperatures between -20°C and +45°C
- Cooling output from 10 kW to 35 kW in 5 kW increments
- Setpoint temperature +24°C for the LCP DX

16 Further technical information

16.3.2 LCP DX

Ambient temperature	-20°C					
Cooling capacity [kW]	10	15	20	25	30	35
Server air inlet temperature [°C]	24	24	24	24	24	24
Server air outlet temperature [°C]	28	29.5	32	35	37	40
Delta T [°C]	4	5.5	8	11	13	16
Power consumption LCP DX [kW]						
Power consumption condenser [kW]	0	0	0.13	0.13	0.13	0.13

Tab. 33: Cooling capacity for an ambient temperature of -20°C

Ambient temperature	-10°C					
Cooling capacity [kW]	10	15	20	25	30	35
Server air inlet temperature [°C]	24	24	24	24	24	24
Server air outlet temperature [°C]	28	29.5	32	35	37	40
Delta T [°C]	4	5.5	8	11	13	16
Power consumption LCP DX [kW]						
Power consumption condenser [kW]	0	0.13	0.13	0.13	0.13	0.13

Tab. 34: Cooling capacity for an ambient temperature of -10°C

Ambient temperature	0°C					
Cooling capacity [kW]	10	15	20	25	30	35
Server air inlet temperature [°C]	24	24	24	24	24	24
Server air outlet temperature [°C]	28	29.5	32	35	37	40
Delta T [°C]	4	5.5	8	11	13	16
Power consumption LCP DX [kW]	1.40	2.00	2.60	3.35	4.30	5.70
Power consumption condenser [kW]	0.13	0.13	0.13	0.13	0.13	0.17

Tab. 35: Cooling capacity for an ambient temperature of 0°C

Ambient temperature	10°C					
Cooling capacity [kW]	10	15	20	25	30	35
Server air inlet temperature [°C]	24	24	24	24	24	24
Server air outlet temperature [°C]	28	29.5	32	35	37	40
Delta T [°C]	4	5.5	8	11	13	16
Power consumption LCP DX [kW]	1.60	2.30	3.05	4.00	5.20	7.10
Power consumption condenser [kW]	0.13	0.13	0.13	0.13	0.17	0.2

Tab. 36: Cooling capacity for an ambient temperature of 10°C

16 Further technical information

Ambient temperature	20°C					
Cooling capacity [kW]	10	15	20	25	30	35
Server air inlet temperature [°C]	24	24	24	24	24	24
Server air outlet temperature [°C]	28	29.5	32	35	37	40
Delta T [°C]	4	5.5	8	11	13	16
Power consumption LCP DX [kW]	1.80	2.60	3.50	4.80	6.50	8.90
Power consumption condenser [kW]	0.13	0.13	0.17	0.2	0.24	0.35

Tab. 37: Cooling capacity for an ambient temperature of 20°C

Ambient temperature	35°C					
Cooling capacity [kW]	10	15	20	25	30	35
Server air inlet temperature [°C]	24	24	24	24	24	24
Server air outlet temperature [°C]	28	29.5	32	35	37	40
Delta T [°C]	4	5.5	8	11	13	16
Power consumption LCP DX [kW]	2.50	3.60	5.10	7.40	10.60	14.20
Power consumption condenser [kW]	0.37	0.56	0.97	1.12	1.12	1.12

Tab. 38: Cooling capacity for an ambient temperature of 35°C

Ambient temperature	45°C					
Cooling capacity [kW]	10	15	20	25	28	
Server air inlet temperature [°C]	24	24	24	24	24	
Server air outlet temperature [°C]	28	29.5	32	35	36	
Delta T [°C]	4	5.5	8	11	12	
Power consumption LCP DX [kW]	3.80	5.20	7.00	10.80	15.50	
Power consumption condenser [kW]	1.12	1.12	1.12	1.12	1.12	

Tab. 39: Cooling capacity for an ambient temperature of 45°C

16 Further technical information

16.3.3 LCP DX/FC

Ambient temperature	-20°C					
Cooling capacity [kW]	10	15	20	25	30	35
Server air inlet temperature [°C]	24	24	24	24	24	24
Server air outlet temperature [°C]	28	29.5	32	35	37	40
Delta T [°C]	4	5.5	8	11	13	16
Power consumption LCP DX (compressor and fans) [kW]	0.201	0.390	0.534	0.675	0.945	1.212
Power consumption LCP DX (pump) [kW]	0.08	0.08	0.08	0.08	0.08	0.08
Power consumption condenser [kW]	0	0	0.5	0.5	0.5	0.5

Tab. 40: Cooling capacity for an ambient temperature of -20°C

Ambient temperature	-10°C					
Cooling capacity [kW]	10	15	20	25	30	35
Server air inlet temperature [°C]	24	24	24	24	24	24
Server air outlet temperature [°C]	28	29.5	32	35	37	40
Delta T [°C]	4	5.5	8	11	13	16
Power consumption LCP DX (compressor and fans) [kW]	0.201	0.390	0.534	0.675	0.945	1.212
Power consumption LCP DX (pump) [kW]	0.08	0.08	0.08	0.08	0.08	0.12
Power consumption condenser [kW]	0.5	0.5	0.5	0.5	0.5	0.5

Tab. 41: Cooling capacity for an ambient temperature of -10°C

Ambient temperature	0°C					
Cooling capacity [kW]	10	15	20	25	30	35
Server air inlet temperature [°C]	24	24	24	24	24	24
Server air outlet temperature [°C]	28	29.5	32	35	37	40
Delta T [°C]	4	5.5	8	11	13	16
Power consumption LCP DX (compressor and fans) [kW]	0.201	0.390	0.534	0.675	0.945	1.212
Power consumption LCP DX (pump) [kW]	0.08	0.08	0.1	0.18	0.63	1.12
Power consumption condenser [kW]	0.5	0.5	0.5	0.5	0.5	0.5

Tab. 42: Cooling capacity for an ambient temperature of 0°C

16 Further technical information

Ambient temperature	10°C					
Cooling capacity [kW]	10	15	20	25	30	35
Server air inlet temperature [°C]	24	24	24	24	24	24
Server air outlet temperature [°C]	28	29.5	32	35	37	40
Delta T [°C]	4	5.5	8	11	13	16
Power consumption LCP DX (compressor and fans) [kW]	0.201	0.390	0.534	0.675	0.945	1.212
Power consumption LCP DX (pump) [kW]	0.08	0.1	1.12	1.12	1.12	1.12
Power consumption condenser [kW]	0.5	0.5	0.5	2.08	3.09	3.09

Tab. 43: Cooling capacity for an ambient temperature of 10°C

Ambient temperature	20°C					
Cooling capacity [kW]	10	15	20	25	30	35
Server air inlet temperature [°C]	24	24	24	24	24	24
Server air outlet temperature [°C]	28	29.5	32	35	37	40
Delta T [°C]	4	5.5	8	11	13	16
Power consumption LCP DX (compressor and fans) [kW]	0.201	1.8	2.6	3.5	4.8	6.5
Power consumption LCP DX (pump) [kW]	1.12	1.12	1.12	1.12	1.12	1.12
Power consumption condenser [kW]	3.87	2.08	2.08	3.09	3.09	3.87

Tab. 44: Cooling capacity for an ambient temperature of 20°C

Ambient temperature	35°C					
Cooling capacity [kW]	10	15	20	25	30	35
Server air inlet temperature [°C]	24	24	24	24	24	24
Server air outlet temperature [°C]	28	29.5	32	35	37	40
Delta T [°C]	4	5.5	8	11	13	16
Power consumption LCP DX (compressor and fans) [kW]	Free cooling not possible	Free cooling not possible	Free cooling not possible	Free cooling not possible	Free cooling not possible	Free cooling not possible
Power consumption LCP DX (pump) [kW]	Free cooling not possible	Free cooling not possible	Free cooling not possible	Free cooling not possible	Free cooling not possible	Free cooling not possible
Power consumption condenser [kW]	Free cooling not possible	Free cooling not possible	Free cooling not possible	Free cooling not possible	Free cooling not possible	Free cooling not possible

Tab. 45: Cooling capacity for an ambient temperature of 35°C

16 Further technical information

Ambient temperature	45°C					
Cooling capacity [kW]	10	15	20	25	30	35
Server air inlet temperature [°C]	24	24	24	24	24	24
Server air outlet temperature [°C]	28	29.5	32	35	37	40
Delta T [°C]	4	5.5	8	11	13	16
Power consumption LCP DX (compressor and fans) [kW]	Free cooling not possible	Free cooling not possible	Free cooling not possible	Free cooling not possible	Free cooling not possible	Free cooling not possible
Power consumption LCP DX (pump) [kW]	Free cooling not possible	Free cooling not possible	Free cooling not possible	Free cooling not possible	Free cooling not possible	Free cooling not possible
Power consumption condenser [kW]	Free cooling not possible	Free cooling not possible	Free cooling not possible	Free cooling not possible	Free cooling not possible	Free cooling not possible

Tab. 46: Cooling capacity for an ambient temperature of 45°C

16.4 Overview drawing

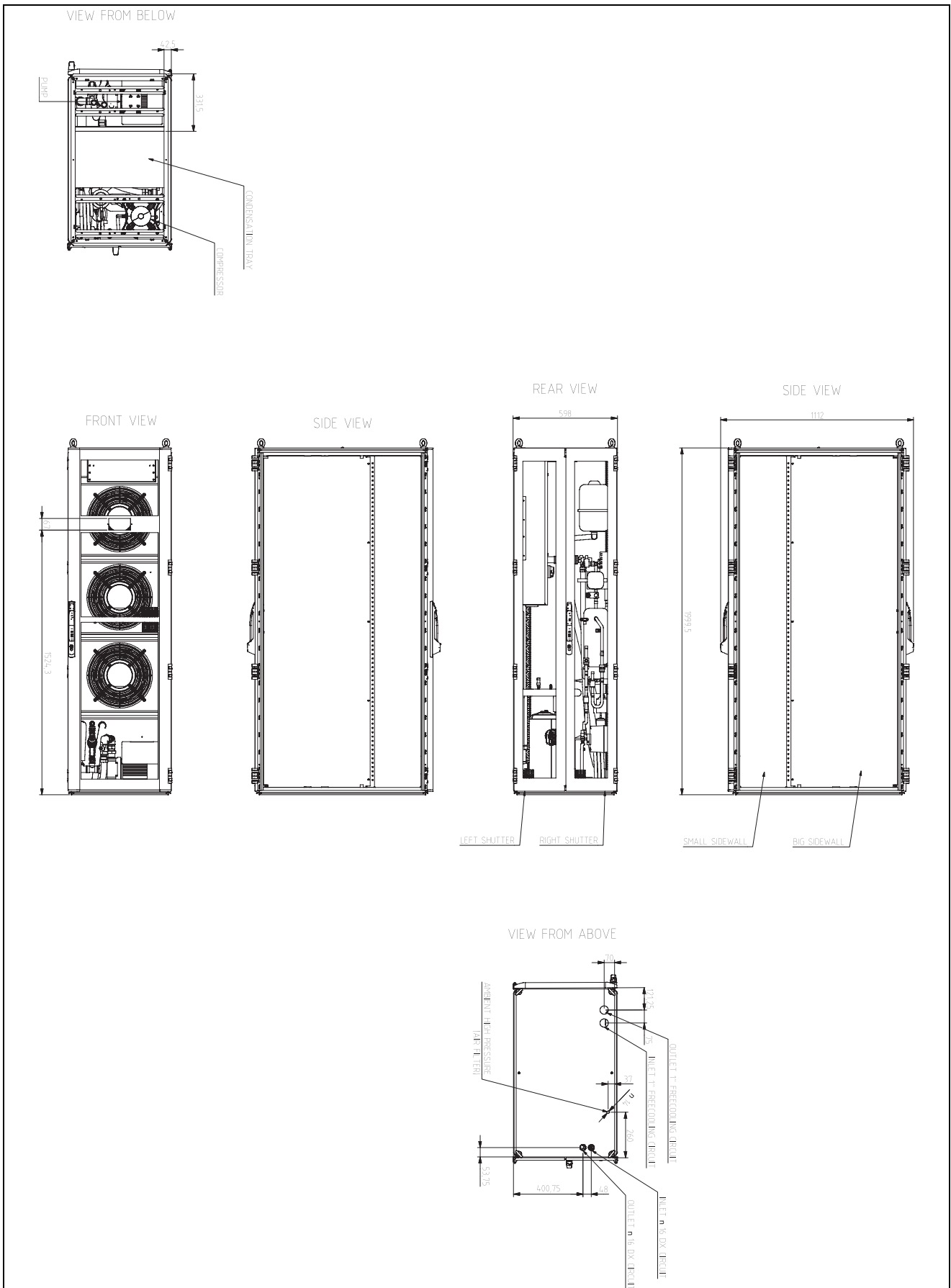

Fig. 68: Overview drawing 1 of the LCP DX (depth 1000 mm)

16 Further technical information

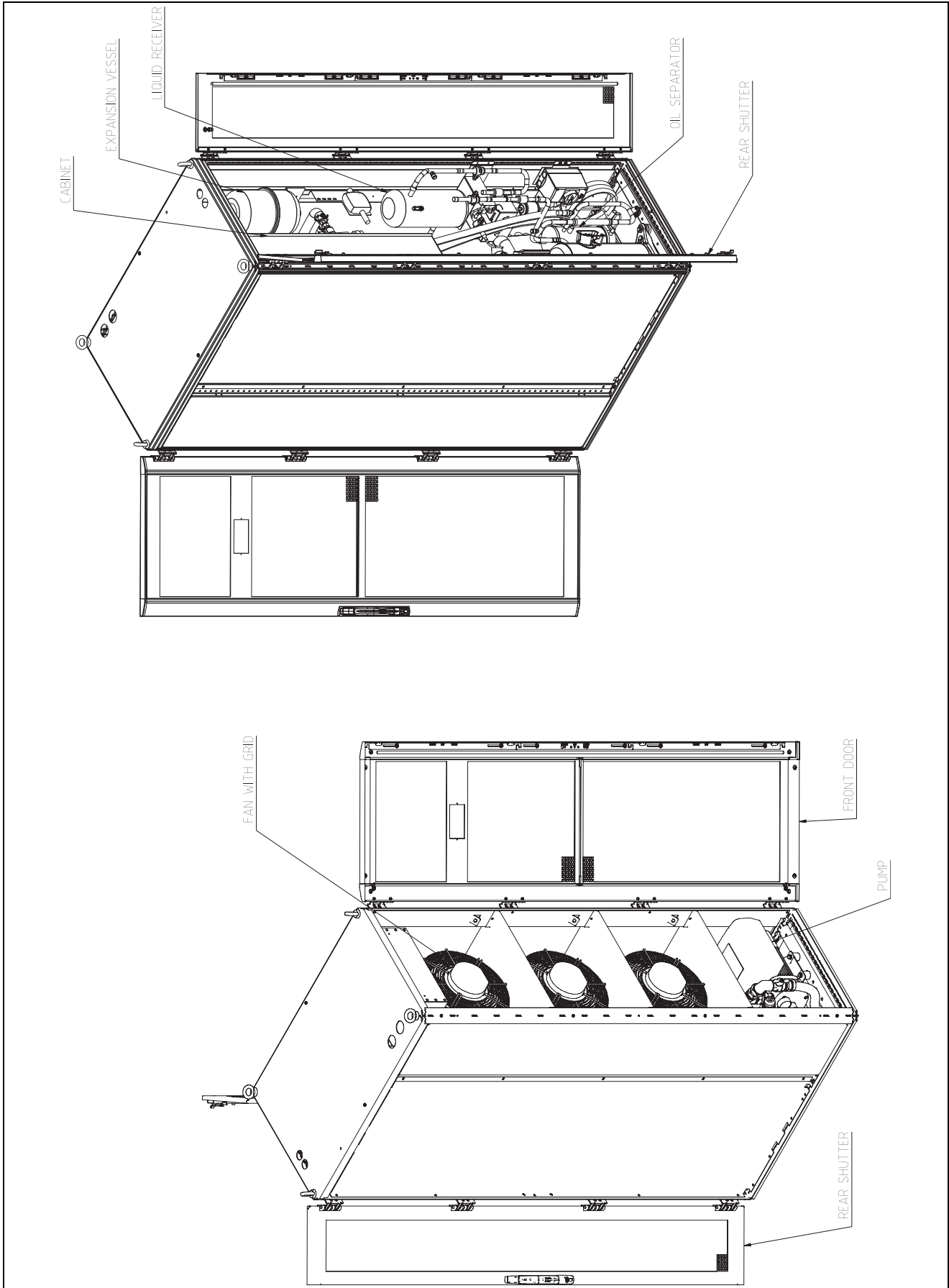

Fig. 69: Overview drawing 2 of the LCP DX (depth 1000 mm)

16 Further technical information

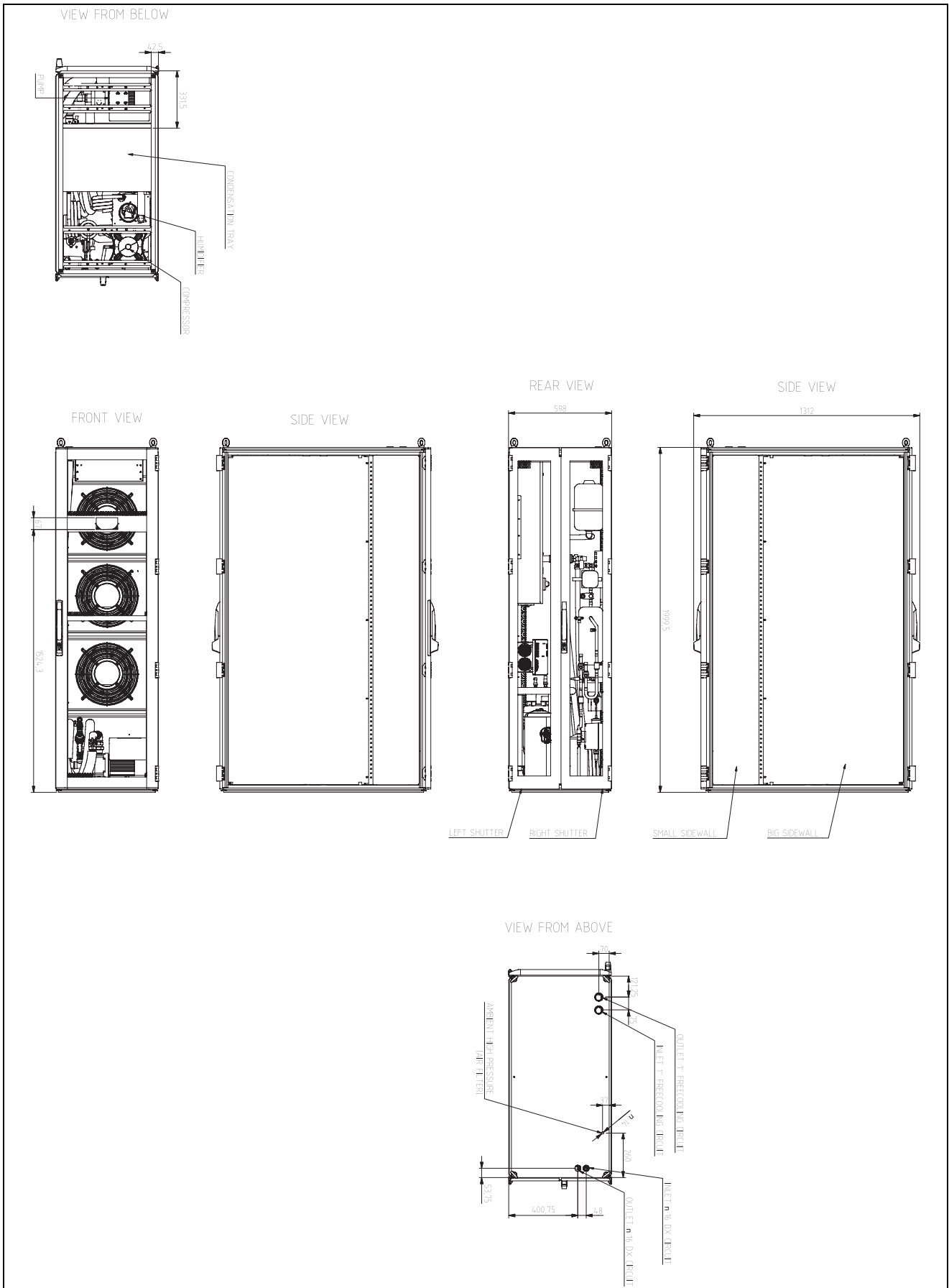

Fig. 70: Overview drawing 1 of the LCP DX (depth 1200 mm)

16 Further technical information

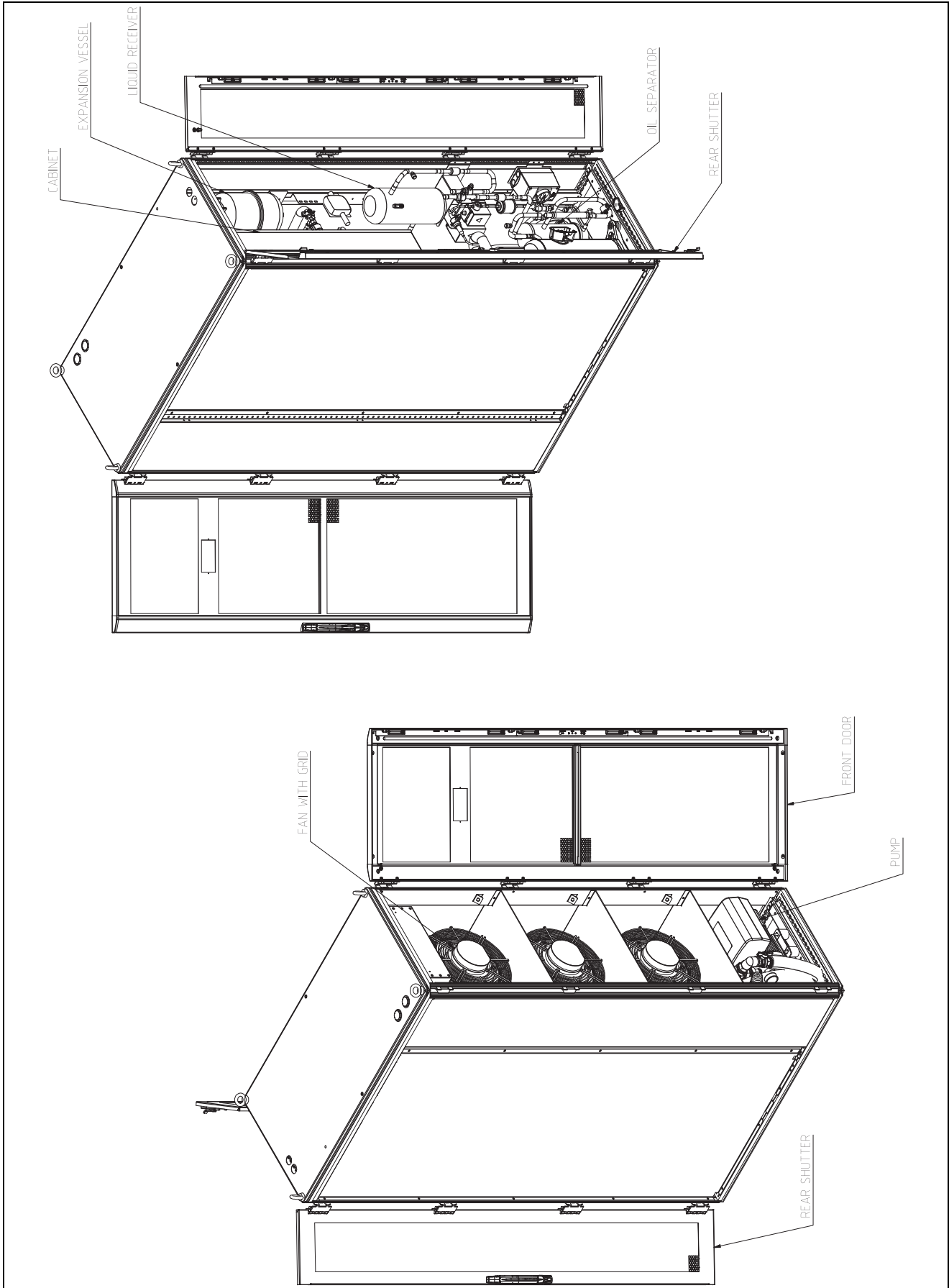

Fig. 71: Overview drawing 2 of the LCP DX (depth 1200 mm)

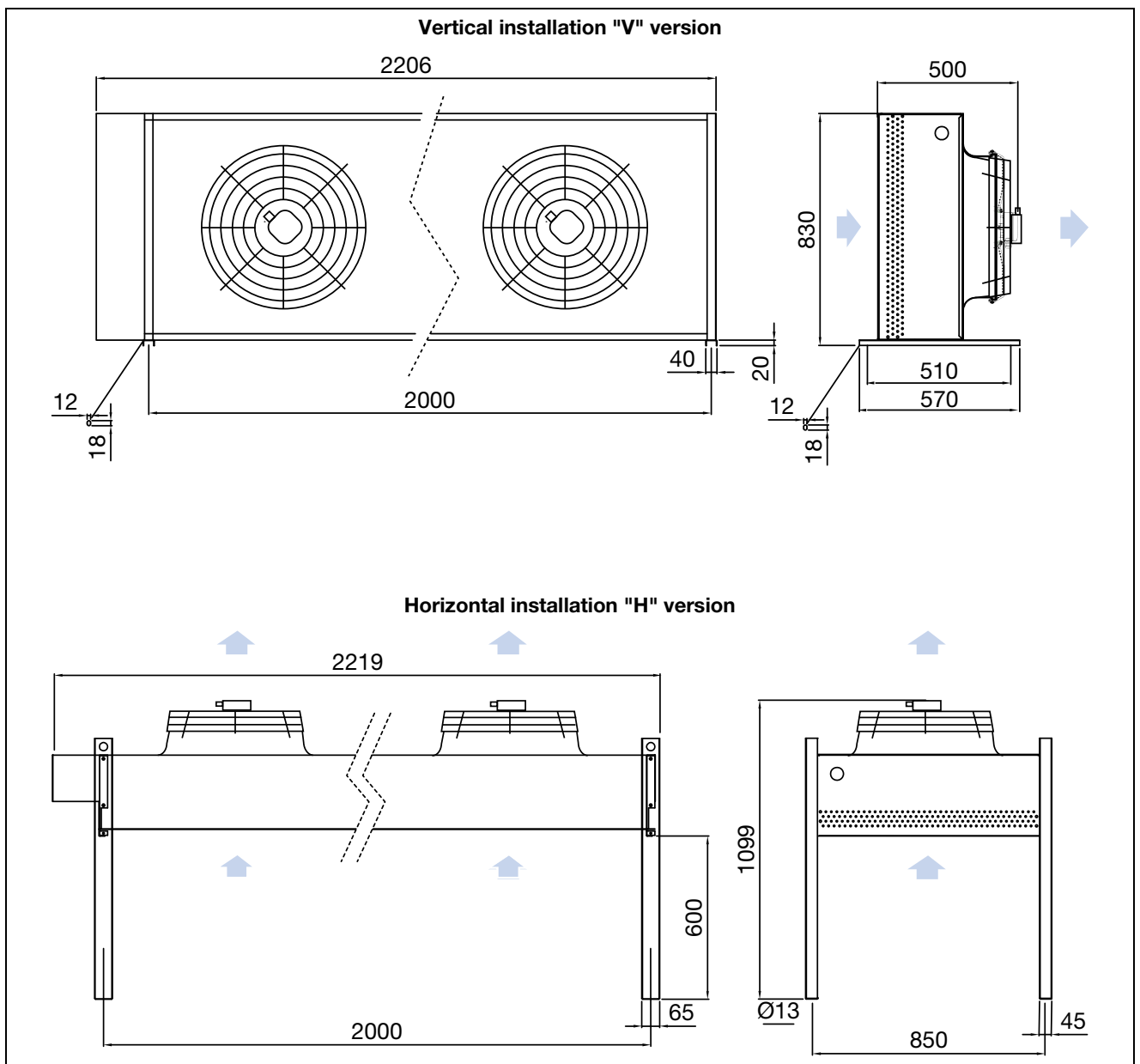

Fig. 72: Installation diagram of the standard condenser (3311.370)

16 Further technical information

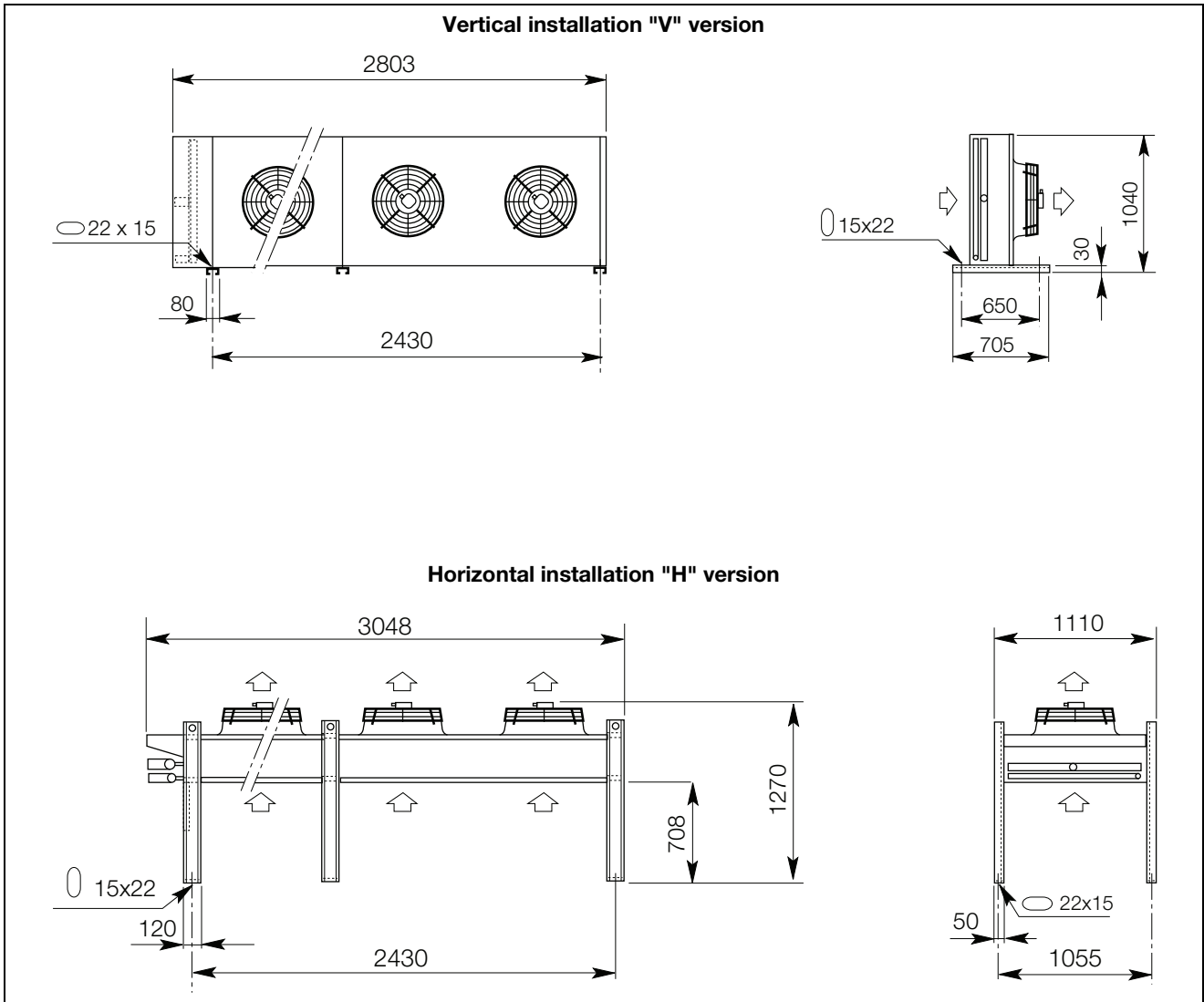

Fig. 73: Installation diagram of the condenser for indirect free cooling (3311.380)

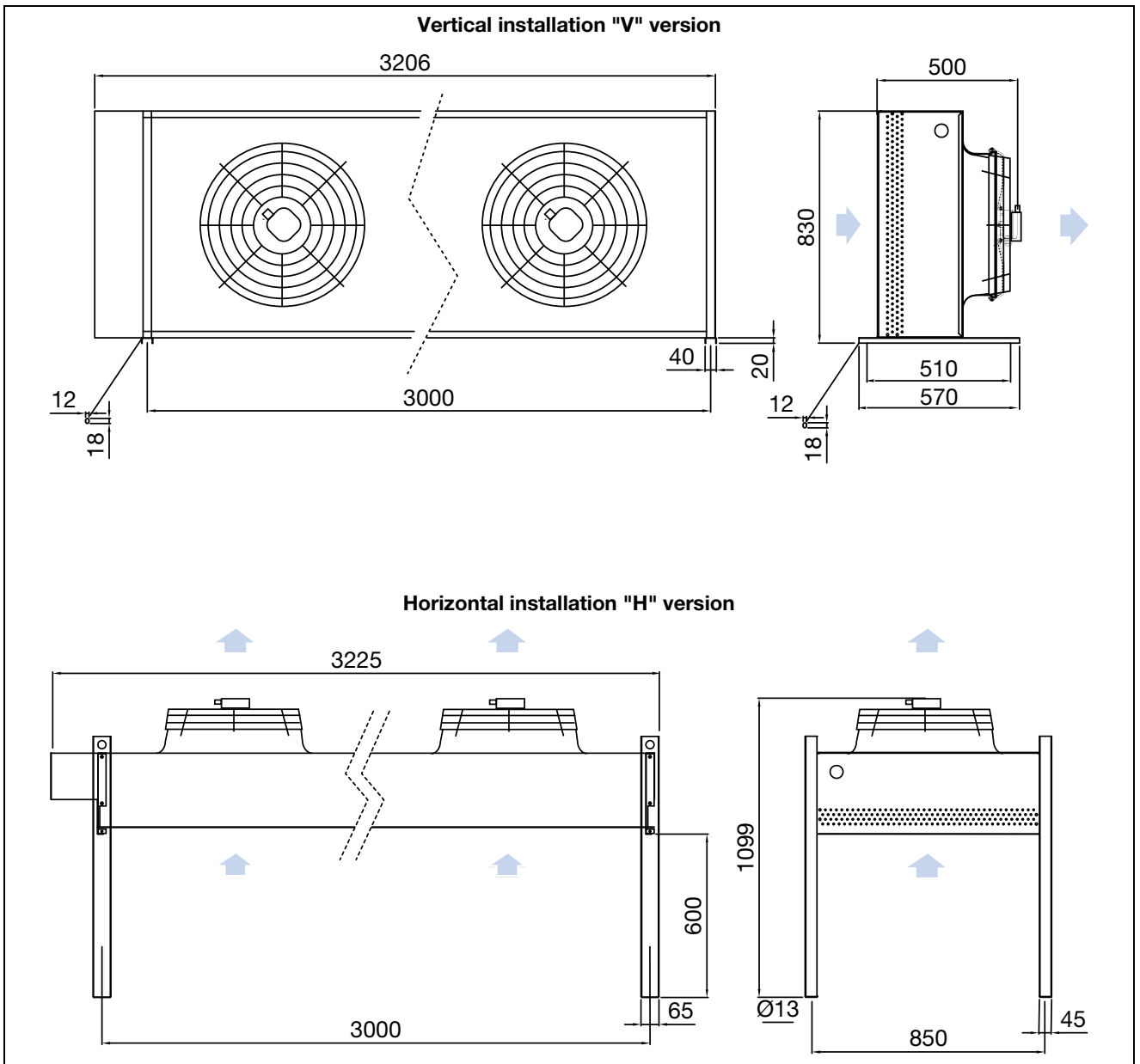

Fig. 74: Installation diagram of the high temperature condenser (3311.XXX)

16 Further technical information

16.5 Piping and instrumentation diagram to DIN EN 1861:1998

16.5.1 LCP DX

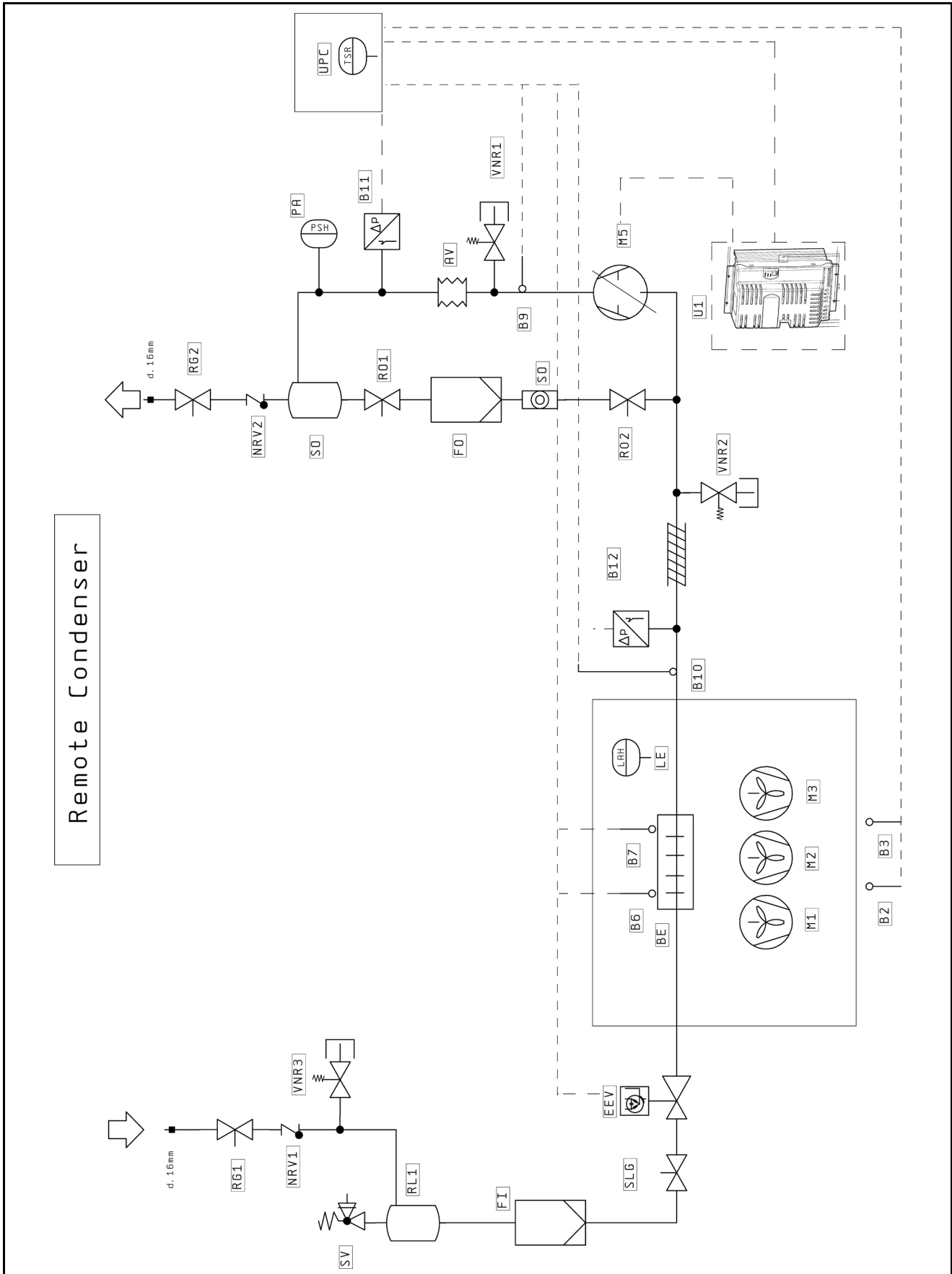

Fig. 75: Piping and instrumentation diagram

Bill of materials

RIEKELL 11.07.2003

Item designation	Amount	Um	Article number	Designation	Manufacturer	Internal number	P/P
SV	1	ST	3060/23C450	VALVISTIC CASTEL 3060/23C450	CASTEL SR	925507	3.0
RL1	1	ST	140.0493.A RV-140X336	RICLIO 4. FRIGOMEK 140.0493.A	FRIGO MEC SPA	925568	3.0
FL	1	ST	DTG-808 16mm	FILTER DEIDR SHNIUR DTG-808 16mm	SANIUR	926482	3.1
SL6	1	ST	VBL502	VALV LID OFFENHANGER VBL502	OFFENHANGER	917298	3.1
R61	1	ST	68C16s 00967023	VALV REF HAN DANFOSS 68C16s	DANFOSS	926175	3.1
NRV1	1	ST	NRV16s	NO RETURN VALVE DANFOSS NRV16s R410A	DANFOSS	920736	3.1
EEV	1	ST	EZV355S40	VALVEXP ELEITR CAREL EZV355S40	CAREL	926176	3.1
VNR3	1	ST	CS3110094	SCHR TUBE M 5/16" SAE	FRIGO SYSTEM SPA	917253	3.1
VNR3	1	ST	CS3110871	SCHRADER VALVE 5/16"	FRIGO SYSTEM SPA	917254	3.1
VNR3	1	ST	W64460501	SCHR CAP F 5/16" SAE	FRIGO SYSTEM SPA	917255	3.1
M1	1	ST	R36310-RR05-H1	RADIAL FAN EBM R36310-RR05-H1	EMPAFST SRL	926483	3.1
B6	1	ST	EV Z522E0 72 4 25 485 12 R10S	COIL HE EV Z522E0 72 4 25 485 12 R10S	LUVIATA GHALPAL G8BH	926504	3.3
B2	1	ST	NTC060MP00	PROBE-TEMP NTC CAREL NTC060MP00	CAREL	903061	3.3
B2	1	ST	NTC060MP00	PROBE-TEMP NTC CAREL NTC060MP00	CAREL	903061	3.3
M2	1	ST	R36310-RR05-H1	RADIAL FAN EBM R36310-RR05-H1	EMPAFST SRL	926483	3.3
B7	1	ST	NTC060MP00	PROBE-TEMP NTC CAREL NTC060MP00	CAREL	903061	3.3
B3	1	ST	NTC060MP00	PROBE-TEMP NTC CAREL NTC060MP00	CAREL	903061	3.3
M3	1	ST	R36310-RR05-H1	RADIAL FAN EBM R36310-RR05-H1	EMPAFST SRL	926483	3.3
LE	1	ST	221974	LEVEL SWITCH 6EHS LS-3	SIKA SYSTEMTECHNIK	317928	3.4
B10	1	ST	NTC060HF01	PROBE-TEMP NTC CAREL NTC060HF01	CAREL	902230	3.4
B12	1	ST	SPK10043R0	TRASD-PRES -1+17.3 bar CAREL SPK10043R0	CAREL	916015	3.5
VNR2	1	ST	CS3110094	SCHR TUBE M 5/16" SAE	FRIGO SYSTEM SPA	917253	3.6
VNR2	1	ST	CS3110871	SCHRADER VALVE 5/16"	FRIGO SYSTEM SPA	917254	3.6
VNR2	1	ST	W64460501	SCHR CAP F 5/16" SAE	FRIGO MEC SPA	917255	3.6
S0	1	ST	103.0030.P	OIL SEPARATOR 1.75L FRIGOMEK 103.0030.P	DANFOSS	926175	3.6
R62	1	ST	68C16s 00967023	VALV REF HAN DANFOSS 68C16s	DANFOSS	920736	3.6
NRV2	1	ST	NRV16s	NO RETURN VALVE DANFOSS NRV16s R410A	DANFOSS	920736	3.6
R01	1	ST	6420/M12	VALV REF HAN CASTEL 6420-M12	CASTEL SR	904300	3.6
F0	1	ST	4520/2	OIL FILTER CASTEL 4520/2 FF 1/4 DDS	CASTEL SR	926487	3.6
S0	1	ST	3940/2	SIGHT GLASS ART. 3940/2 FF 06 DDS	CASTEL SR	926488	3.6
R02	1	ST	6420/M12	VALV REF HAN CASTEL 6420-M12	CASTEL SR	904300	3.6
M5	1	ST	ANB52FKFMT	COMPRESSOR SCROLL MITSUBISHI ANB52FKFMT	MITSUBISHI	926501	3.7
U1	1	ST	PSD1035420	INVERTER ROT BRUSH CAREL PSD1035420	CAREL	926174	3.7
AV	1	ST	AVV116PN50	REF TUBE ANTI V 16mm STAINST PN50	VERCO	921446	3.7
VNR1	1	ST	CS3110094	SCHR TUBE M 5/16" SAE	FRIGO SYSTEM SPA	917253	3.7
VNR1	1	ST	CS3110871	SCHRADER VALVE 5/16"	FRIGO SYSTEM SPA	917254	3.7
VNR1	1	ST	W64460501	SCHR CAP F 5/16" SAE	FRIGO SYSTEM SPA	917255	3.7
B9	1	ST	NTC060HT00	PROBE-TEMP NTC CAREL NTC060HT00	CAREL	916014	3.7
B11	1	ST	SPK100B6R0	TRASD-PRES +0+45 bar CAREL SPK100B6R0	CAREL	916016	3.7
PA	1	ST	P100CP-1420	PRESSHP PSRH FISS 42	JOHNSON	925503	3.7

Fig. 76: Parts list, piping and instrumentation diagram

16 Further technical information

16.5.2 LCP DX/FC

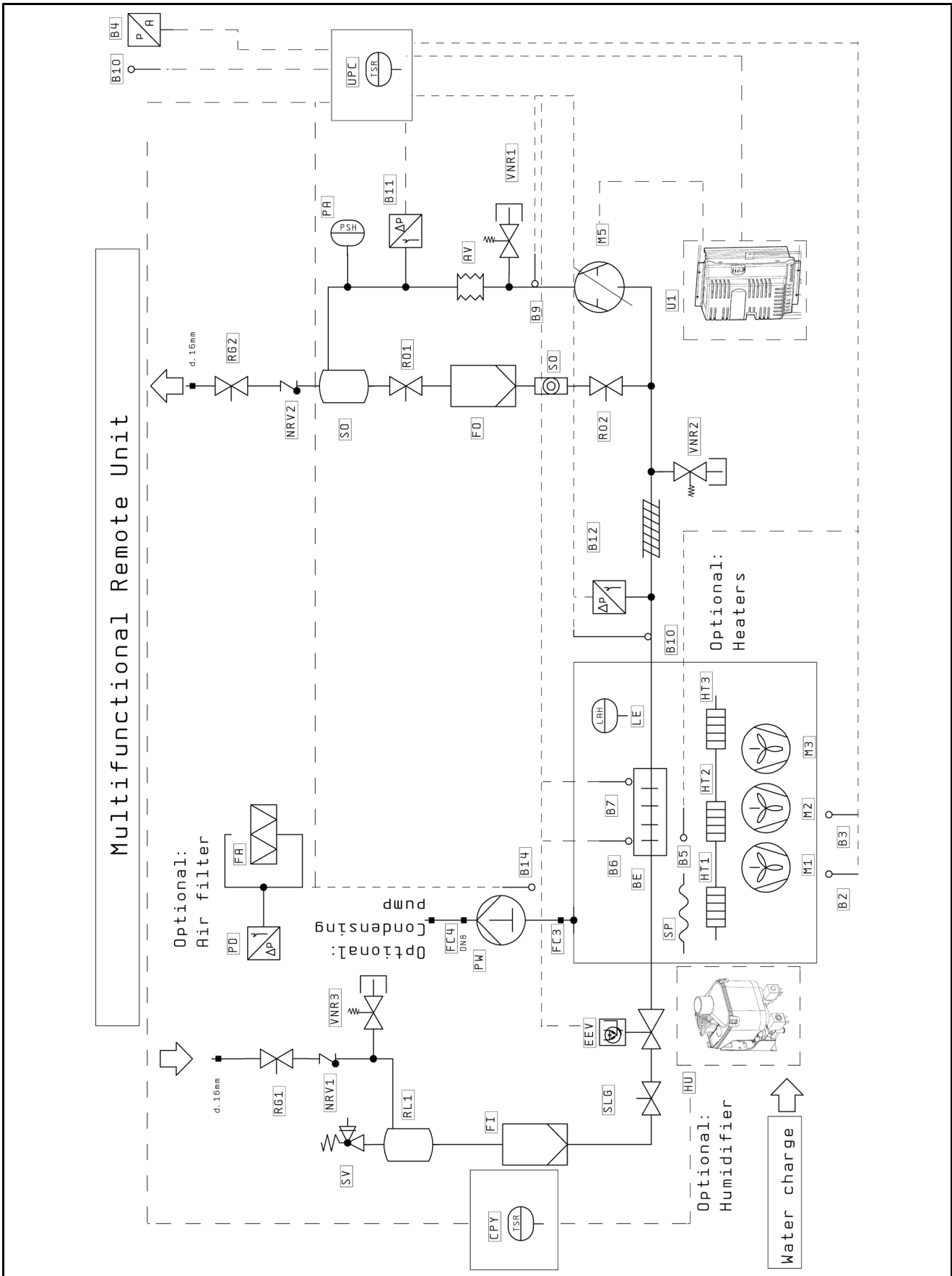

Fig. 77: Piping and instrumentation diagram

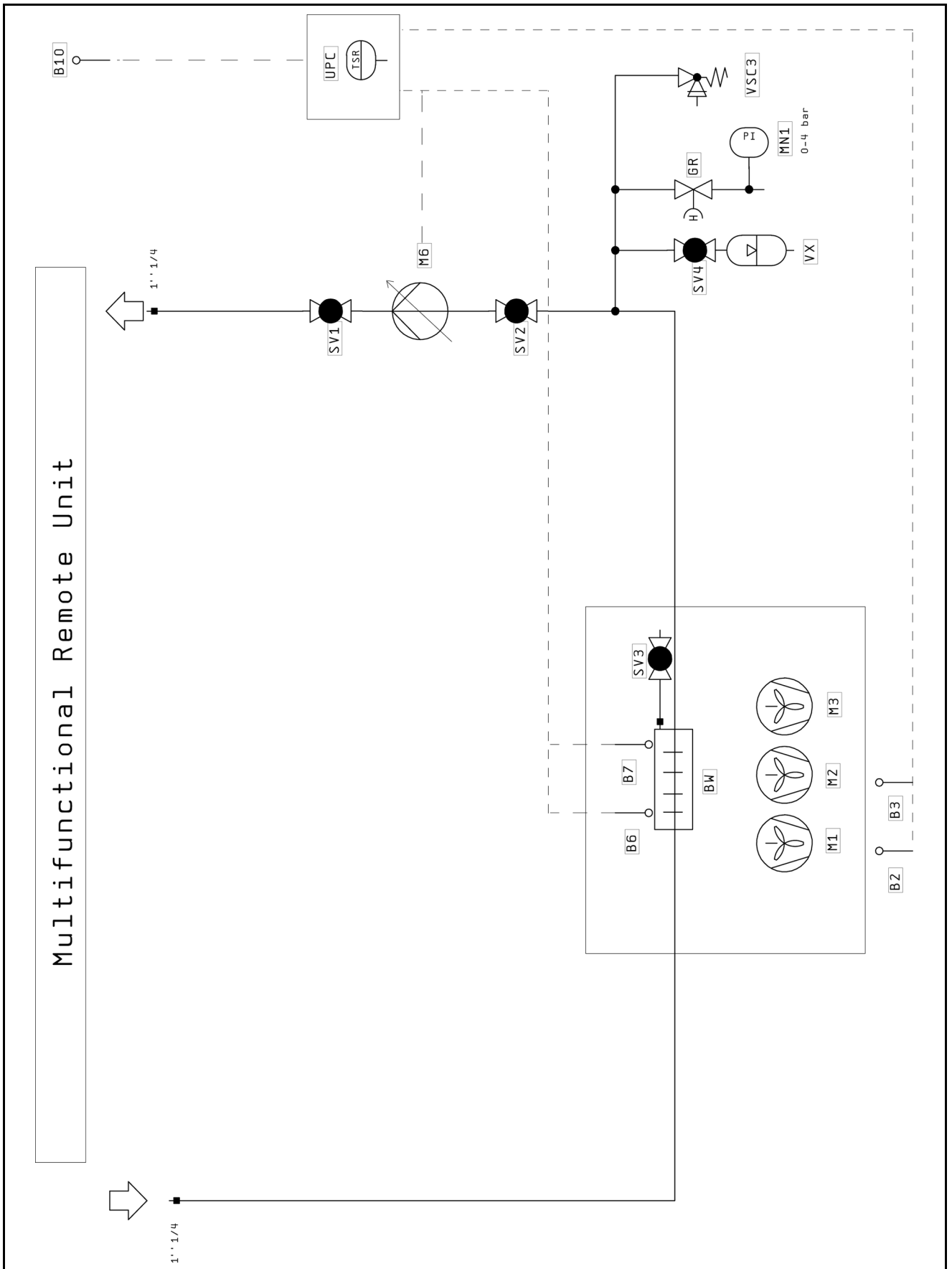

Fig. 78: Piping and instrumentation diagram (optional free cooling)

16 Further technical information

Bill of materials

RICKELL 11.07.2003

Item designation	Amount	Um	Article number	Designation	Manufacturer	Internal number	P/P
SV	1	ST	3060/23C450	VALVISC CASTEL 3060/23C450	CASTEL SR	925507	3.0
RL1	1	ST	140.0493.R RV-140X336	RICILLO 4. 4. FRIGOMEC 140.0493.R	FRIGO MEC SPA	925568	3.0
F1	1	ST	D16-808 10mm	FILTER DEIOR SANHUA D16-808 10mm	SANHUA	926462	3.1
SLG	1	ST	VBL502	VALV L10 OFFENMÄNGER VBL502	OFFENMÄNGER	917298	3.1
RG1	1	ST	6BC16s 00967023	VALV REF MAN DANFOSS 6BC16s	DANFOSS	926175	3.1
NRV1	1	ST	NRV16s	NO RETURN VALVE DANFOSS NRV16s R410A	DANFOSS	920736	3.1
EEV	1	ST	EZV35S5H40	VALVEXP ELETRIC CAREL EZV35S5M40	CAREL	926176	3.1
HU	1	ST	KUET2C0000	CAREL HUMIDIFIER 8 kg/h KUET2C0000	CAREL	926495	3.1
WR3	1	ST	CS3110094	SCHRADER VALVE 5/16"	FRIGO SYSTEM SPA	917253	3.1
WR3	1	ST	CS3110871	SCHRADER VALVE 5/16"	FRIGO SYSTEM SPA	917254	3.1
WR3	1	ST	M64460501	SCHR CAP F 5/16" SRE	FRIGO SYSTEM SPA	917255	3.1
SP	1	ST	UUKDP53000	PIPE STEAM DIFF CAREL UUKDP53000	CAREL	921491	3.2
HT1	1	ST	160201.00	AIR ELECTRIC HEAT RESISTOR S. R. L. 2000W	RESISTOR SRL	926500	3.2
PD	1	ST	DBL-205C	PRESS DIFF AIR INDITECK DBL-205C	INDUSTRIE TECHNIK SRL	908650	3.2
FC4	1	ST	162873	FAST CONNECTOR 90° 1/8" CRSL-1/8-8	FESTO	925569	3.2
FC4	1	ST	197385	PIPE FESTO PUN-H-8X1.25H	FESTO	925571	3.2
PM	1	ST	315476	CONDENSING PUMP ECKERLE ETU100-P/C	RITTAL WT	925573	3.2
FC3	1	ST	162873	FAST CONNECTOR 90° 1/8" ENSL-1/8-8	RITTAL WT	925574	3.2
FC3	1	ST	197385	PIPE FESTO PUN-H-8X1.25H	FESTO	925569	3.2
B14	1	ST	DPFC110000	PROBE-HUMID CAREL DPFC110000	CAREL	919084	3.2
B2	1	ST	NTC060MP00	PROBE-TEMP NTC CAREL NTC060MP00	CAREL	903061	3.3
M1	1	ST	R36310-RR05-H1	RADIAL FAN EBM R36310-RR05-H1	EBM PAPST SRL	926483	3.3
BE	1	ST	252ZE+H2007203+032543512+24R10S	LCP 35KK DOUBLE COIL	LUVATA GRITAL GMBH	926505	3.3
HT2	1	ST	160201.00	AIR ELECTRIC HEAT RESISTOR S. R. L. 2000W	RESISTOR SRL	926500	3.3
B6	1	ST	NTC060MP00	PROBE-TEMP NTC CAREL NTC060MP00	CAREL	903061	3.3
FR	1	ST	R05754600SK	HOLDER FOR FILTER HAT CPL ASSEMBLED	CAREL	396204	3.3
B5	1	ST	NTC060MP00	PROBE-TEMP NTC CAREL NTC060MP00	CAREL	903061	3.3
B3	1	ST	NTC060MP00	PROBE-TEMP NTC CAREL NTC060MP00	CAREL	903061	3.3
H2	1	ST	R36310-RR05-H1	RADIAL FAN EBM R36310-RR05-H1	EBM PAPST SRL	926483	3.3
B7	1	ST	NTC060MP00	PROBE-TEMP NTC CAREL NTC060MP00	CAREL	903061	3.3
HT3	1	ST	160201.00	AIR ELECTRIC HEAT RESISTOR S. R. L. 2000W	RESISTOR SRL	926500	3.4
H3	1	ST	R36310-RR05-H1	RADIAL FAN EBM R36310-RR05-H1	EBM PAPST SRL	926483	3.4
LE	1	ST	221974	LEVEL SWITCH GEMS LS-3	SIMA SYSTEMTECHNIK	317928	3.4
B10	1	ST	NTC060HF01	PROBE-TEMP NTC CAREL NTC060HF01	CAREL	902230	3.4
B12	1	ST	SPKT0043R0	TRASD-PRES -1+17.3 bar CAREL SPKT0043R0	CAREL	918015	3.5
WR2	1	ST	CS3110094	SCHR TUBE M 5/16" SRE	FRIGO SYSTEM SPA	917293	3.6
WR2	1	ST	CS3110871	SCHRADER VALVE 5/16"	FRIGO SYSTEM SPA	917294	3.6
WR2	1	ST	M64460501	SCHR CAP F 5/16" SRE	FRIGO SYSTEM SPA	917295	3.6
S0	1	ST	103.0030.P	OIL SEPARATOR 1.75L FRIGOMEC 103.0030.P	FRIGO MEC SPA	926486	3.6
RG2	1	ST	6BC16s 00967023	VALV REF MAN DANFOSS 6BC16s	DANFOSS	926175	3.6
NRV2	1	ST	NRV16s	NO RETURN VALVE DANFOSS NRV16s R410A	DANFOSS	920736	3.6
R01	1	ST	6420/M12	VALV REF MAN CASTEL 6420-M12	CASTEL SR	904300	3.6
F0	1	ST	4520/2	OIL FILTER CASTEL 4520/2 FF 1/4" ODS	CASTEL SR	926487	3.6
S0	1	ST	3940/2	SLIGHT GLASS ART. 3940/2 FF 06 ODS	CASTEL SR	926488	3.6
R02	1	ST	6420/M12	VALV REF MAN CASTEL 6420-M12	CASTEL SR	904300	3.6
H5	1	ST	RN652FKFMT	COMPRESSOR SCROLL MITSUBISHI RN652FKFMT	MITSUBISHI	926174	3.7
U1	1	ST	PSD1035420	INVERTER MDT BRUSH CAREL PSD1035420	CAREL	926501	3.7
RV	1	ST	AVWT16PN50	REF TUBE ANTI V 16mm STAINST PN50	VERCO	921446	3.7
WR1	1	ST	CS3110094	SCHR TUBE M 5/16" SRE	FRIGO SYSTEM SPA	917253	3.7

Fig. 79: Parts list, piping and instrumentation diagram

Bill of materials

RICKEL 11.07.2003

Item designation	Amount	Um	Article number	Designation	Manufacturer	Internal number	P/P
VNR1	1	ST	CS3110871	SCHRAUER VALVE 5/16"	FRIGO SYSTEM SPA	917254	3,7
VNR1	1	ST	H44460501	SCHR. CAP. F. 5/16" SBE	FRIGO SYSTEM SPA	917255	3,7
B9	1	ST	NTC060HT00	PROBE-TEMP NTC CAREL NTC060HT00	CAREL	918014	3,7
B11	1	ST	SPKT008B80	TRASD-PRES +0.45 bar CAREL SPKT008B80	CAREL	918016	3,7
PH	1	ST	F100CP-14ZD	PRESSHP PSRH FISS 4Z	JOHNSON	929503	3,7
B10	1	ST	NTC060HF01	PROBE-TEMP NTC CAREL NTC060HF01	CAREL	902230	3,9
B4	1	ST	DPPC110000	PROBE-HUMID CAREL DPPC110000	CAREL	919084	3,9
B1	1	ST	R30250-R040-A1	RADIAL FAN EBM R30250-R040-A1	EBMPAPST SRL	919367	4,4
B2	1	ST	R30250-R040-A1	HEX F-TUB EV 2522C0 7Z 4 25 190 1Z A08S	EURACOIL SPA	919746	4,4
B3	1	ST	R30250-R040-A1	RADIAL FAN EBM R30250-R040-A1	EBMPAPST SRL	919746	4,4
SV3	1	ST	101-1/8-2Z-TA-HSV	RADIAL FAN EBM R30250-R040-A1	EBMPAPST SRL	919746	4,4
SV1	1	ST	129300100	BALL VALVE A 1/8" SM 21 WITH TOGGLE	TIMMER	315650	4,5
H6	1	ST	CHES-3 R-R-R-V-RODV SRDN	BALL VALVE 2VIE RXF 1" BRASS Cr	LOMBARDA RACCORDI SRL	902695	4,7
SV2	1	ST	124300100	GRUND PUMP CHES-3 R-R-R-V-RODV SRDN	FIORINI	926490	4,7
SV4	1	ST	124300304	BALL VALVE 2VIE RXF 1" BRASS Cr	LOMBARDA RACCORDI SRL	902695	4,7
VX	1	ST	11A00005000	BALL VALVE 2VIE RXF 3/4" BRASS Cr	LOMBARDA RACCORDI SRL	902692	4,7
BR	1	ST	554140	VASO ESPANSIONE ZILMET 5 lt	ZILMET	926489	4,8
YSC3	1	ST	311560	FILLING GROUP CALEFFI 454140 1/2"	CALEFFI	922015	4,8
				SAFETY VALVE CALEFFI 311560	CALEFFI	925272	4,8

Fig. 80: Parts list, piping and instrumentation diagram

16 Further technical information

16.6 Characteristic curve of cooling water pump

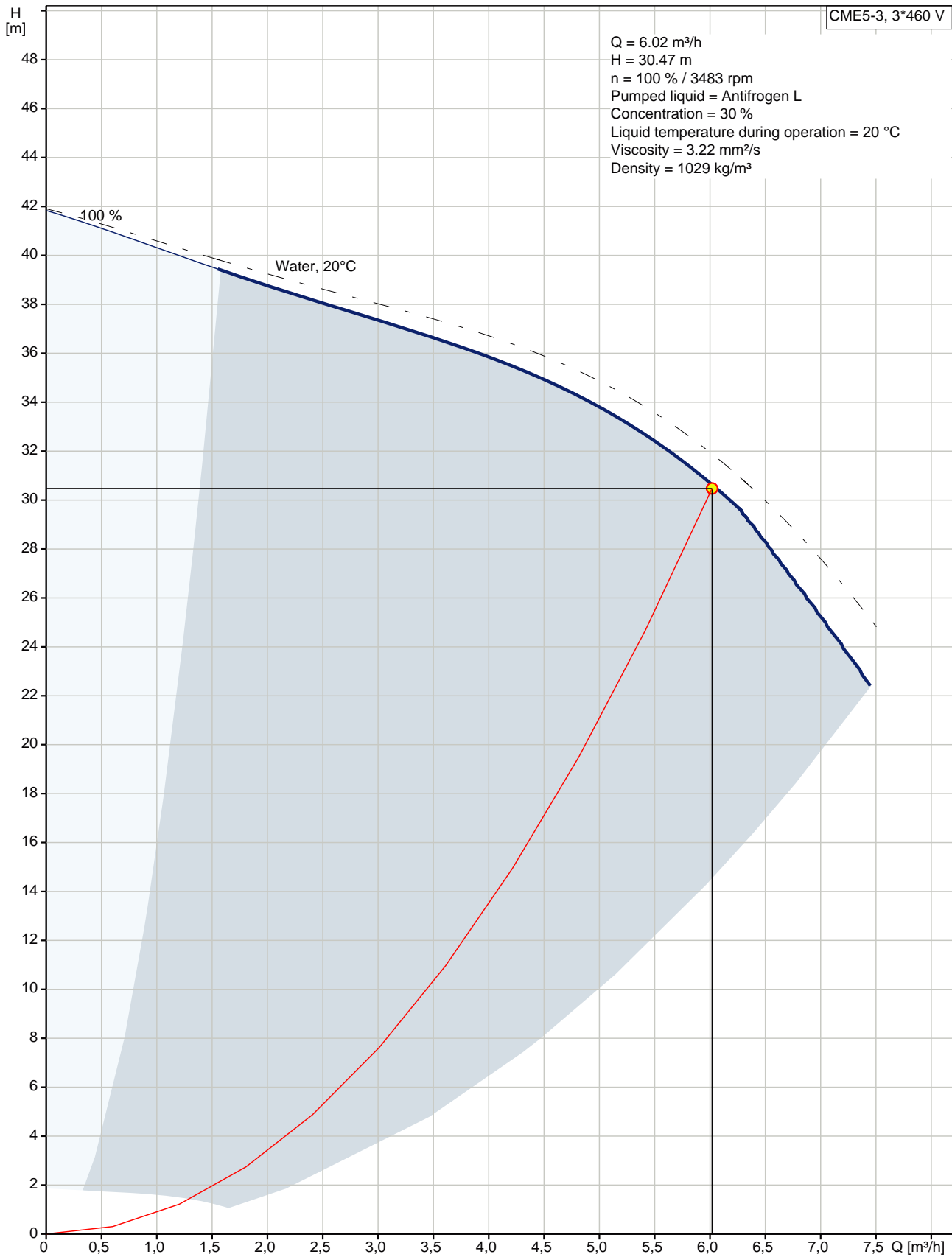

Fig. 81: Characteristic curve of cooling water pump

16.7 Circuit diagram

You can download the circuit diagram of your LCP DX from the Rittal website under the corresponding article number.

- If necessary, please contact Rittal Service (see section 18 "Customer service addresses").

17 Glossary

17 Glossary

1 U server:

1 U servers are very flat and deep, modern high performance servers, whose height corresponds to one height unit (1 U = 44.54 mm, the smallest standard height division). Typical dimensions are (W x D x H) 482.6 mm (19") x 800 mm x 1 U.

These systems normally include 2 CPUs, many GB RAM and hard drives, so that they require up to 100 m³/h cooling air at a maximum of 32°C.

482.6 mm (19") level:

The front sides of the devices built into the server enclosure form the 482.6 mm (19") level.

Blade server:

By orienting dual CPU systems vertically and placing up to 14 units on a common backplane to provide for signal routing and power supply, one has a blade server.

Blade servers can "generate" up to 4.5 kW heat loss per 7 U and 700 mm depth.

"Front to back" cooling principle:

The devices built into the server enclosure are normally cooled according to the "front to back" cooling principle.

Under this cooling principle, cold air supplied by external air conditioning is blown to the front of the server enclosure. The fans in the devices built into the server enclosure direct this air horizontally through the server enclosure. The air is warmed through this process and is exhausted out of the rear of the enclosure.

Hotspot:

A hotspot is the concentration of thermal energy in a small area.

Hotspots normally lead to local overheating and can cause system malfunctions.

Switch:

Multiple servers normally communicate with one another and in the network using switches.

Because as many inputs as possible are located on the front of switches, they frequently have an airflow from the side, not "front to back" cooling.

Hysteresis:

If an upper limit value is overshoot (SetPtHigh) or a lower limit value is undershoot (SetPtLow) a warning or an alarm will be output **immediately**. For a hysteresis of x%, the warning or alarm for undershooting an upper limit value or overshooting a lower limit value clears only for a difference of $x/100 \cdot \text{limit value}$ to the limit value.

18 Customer service addresses

For technical questions, please contact:

Tel.: +49(0)2772 505-9052

E-mail: info@rittal.de

Homepage: www.rittal.com

For complaints or service requests, please contact:

Tel.: +49(0)2772 505-1855

E-mail: service@rittal.de

Rittal GmbH & Co. KG

Auf dem Stützelberg

35745 Herborn

Germany

Rittal – The System.

Faster – better – everywhere.

- Enclosures
- Power Distribution
- Climate Control
- IT Infrastructure
- Software & Services

You can find the contact details of all Rittal companies throughout the world here.



www.rittal.com/contact

RITTAL GmbH & Co. KG
Auf dem Stuetzelberg · 35745 Herborn · Germany
Phone +49 2772 505-0
E-mail: info@rittal.de · www.rittal.com

11.2019

ENCLOSURES

POWER DISTRIBUTION

CLIMATE CONTROL

IT INFRASTRUCTURE

SOFTWARE & SERVICES

FRIEDHELM LOH GROUP

