







**SV**  
3451.505  
3456.505

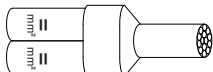
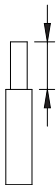

					
IEC	1,5-16 mm <sup>2</sup>				1,5-4 mm <sup>2</sup>
UL	AWG 14-6				
	Cu				
	18-20 mm				
Montage/Assembly	(1a)	(1b)	(1a)		

SV 3451.505

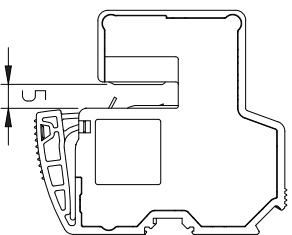

SV 3456.505

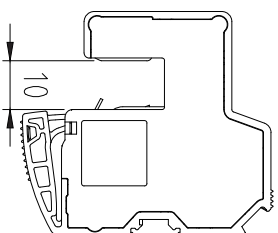

For further information: [www.rittal.com](http://www.rittal.com)

**10 Leiteranschlussklemmen**  
mit Push-in-Anschluss, 1,5 - 16 mm<sup>2</sup>

**10 Conductor connection clamps**  
with push-in connection, 1,5 - 16 mm<sup>2</sup>

**10 Bornes pour raccordement de câbles**  
avec raccordement push-in, 1,5 - 16 mm<sup>2</sup>

Zchng.-Nr. / No. of dwg. : A06816001/SV

Lieferanten-Nr. / No. of supplier :

Montage / Assembly / Montage

1a

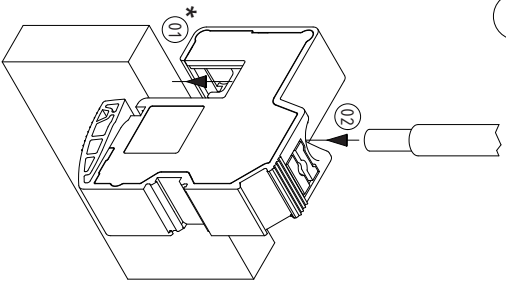

1b

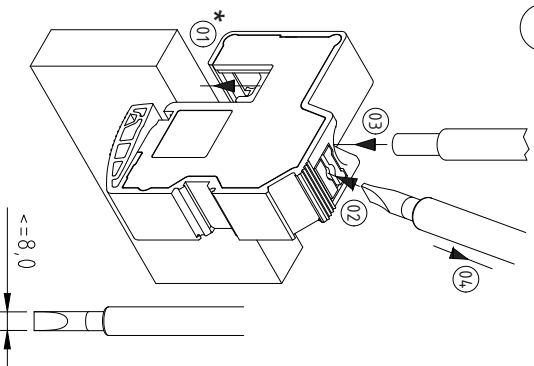

Demontage / Disassembly / Démontage

2

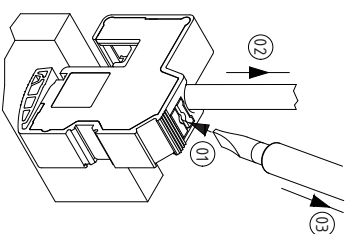

3a

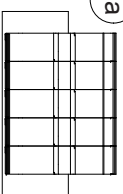

3b

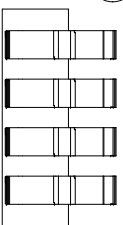

Hinweis / note / notice

