

Rittal – The System.

Faster – better – everywhere.

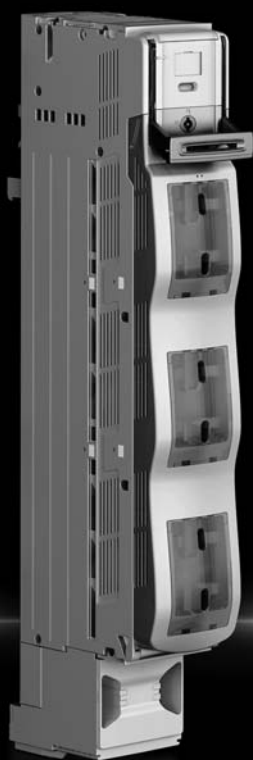

**NH-Lasttrennschaltleiste
Gr. 1 – 3**

**NH slimline switch-disconnectors
Size 1 – 3**

**Coupe-circuit à fusibles HPC
taille 1 – 3**

SV 9677.160

SV 9677.260

SV 9677.360

SV 9677.165

SV 9677.265

SV 9677.365

SV 9677.180

SV 9677.280

SV 9677.380

**Montageanleitung
Assembly instructions
Notice de montage**

ENCLOSURES

POWER DISTRIBUTION

CLIMATE CONTROL

IT INFRASTRUCTURE

SOFTWARE & SERVICES



FRIEDHELM LOH GROUP

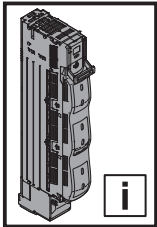

Inhaltsverzeichnis/Contents/Sommaire

DE		EN		FR	
Technische Daten	2	Technical data	2	Caractéristiques techniques	2
Hinweise zur Dokumentation	3	Notes on documentation	3	Remarques relatives à la documentation	3
Sicherheitshinweise	3	Safety notes	3	Consignes de sécurité	3
Varianten	4	Variants	4	Modèles	4
Schiensystem	4/5	Busbar system	4 / 5	Jeux de barres	4/5
Montage	6	Assembly	6	Montage	6
Anschlüsse	7	Connections	7	Raccordements	7
Sicherungen auswechseln	8	Change the fuse	8	Remplacement des fusibles	8
Abschließbarkeit	9	Locking the fuse holder	9	Cadenassage	9
Plombieren	9	Sealing	9	Plombage	9
Spannungsprüfung	10	Voltage test	10	Test de tension	10
Parkposition	10	Parking position	10	Position d'attente	10
Zubehör – Meldeschalter, Einbau	10	Accessories – Pilot switch, assembly	10	Accessoires – Micro-commutateurs, montage à l'intérieur	10
Elektronische Sicherungsüberwachung	11	Electronic fuse monitoring	11	Surveillance des fusibles électroniques	11

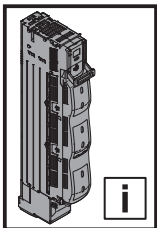

Technische Daten/Technical specifications/Caractéristiques techniques

Best.-Nr./Model No. /Référence	SV 9677.160	SV 9677.165	SV 9677.260	SV 9677.265	SV 9677.360	SV 9677.365
Best.-Nr. (mit elektronischer Sicherungsüberwachung) Model No. (with electronic fuse monitoring) Référence (avec surveillance électronique des fusibles)	SV 9677.180 ¹⁾	–	SV 9677.280 ¹⁾	–	SV 9677.380 ¹⁾	–
Baugröße/Size/Taille	1	1	2	2	3	3
Ausführung Design Modèle	3-polig schaltbar 3-pole, switchable tripolaire, commutable	3-polig schaltbar 3-pole, switchable tripolaire, commutable	3-polig schaltbar 3-pole, switchable tripolaire, commutable	3-polig schaltbar 3-pole, switchable tripolaire, commutable	3-polig schaltbar 3-pole, switchable tripolaire, commutable	3-polig schaltbar 3-pole, switchable tripolaire, commutable
Bemessungsbetriebsstrom max. A Rated operating current max. A Courant nominal max. A	250	250	400	400	630	500
Bemessungsbetriebsspannung V, ~ Rated operating voltage V, ~ Tension nominale V, ~	690, 3~ ¹⁾ 400, 3~	690, 3~	690, 3~ ¹⁾ 400, 3~	690, 3~	690, 3~ ¹⁾ 400, 3~	690, 3~
Polzahl Number of poles Nombre de pôles	3-polig 3-pole 3 pôles	3-polig 3-pole 3 pôles	3-polig 3-pole 3 pôles	3-polig 3-pole 3 pôles	3-polig 3-pole 3 pôles	3-polig 3-pole 3 pôles
Leitungsabgang Cable outlet Départ de ligne	Unten Bottom En bas	Oben Top En haut	Unten Bottom En bas	Oben Top En haut	Unten Bottom En bas	Oben Top En haut
Anschlussart Type of connection Type de raccordement	Bolzen M12 Bolt M12 Boulon M12	Bolzen M12 Bolt M12 Boulon M12	Bolzen M12 Bolt M12 Boulon M12	Bolzen M12 Bolt M12 Boulon M12	Bolzen M12 Bolt M12 Boulon M12	Bolzen M12 Bolt M12 Boulon M12
Anschluss von Rundleitern mm ² Connection of round conductors mm ² Raccordement de câbles cylindriques mm ²	6 – 240	6 – 240	6 – 240	6 – 240	6 – 240	6 – 240
Für Schienensysteme mit Mittenabstand mm For bar systems with centre-to-centre spacing mm Pour jeux de barres avec entraxe mm	185	185	185	185	185	185
Für Schienenstärke mm/For bar thickness mm/ Pour épaisseur de barre mm	10	10	10	10	10	10
Lagerungstemperatur/Storage temperature Plage de température de stockage	-20°C...+80°C	-20°C...+80°C	-20°C...+80°C	-20°C...+80°C	-20°C...+80°C	-20°C...+80°C

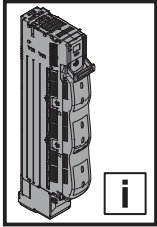

Hinweise zur Dokumentation/Notes on documentation/ Remarques relatives à la documentation

DE

Die **Montageanleitung** richtet sich an alle Personen, die über eine entsprechende Fachausbildung verfügen, um Schaltschränke normgerecht mit elektrischen, elektronischen, mechanischen und pneumatischen Betriebsmitteln auszurüsten bzw. zu montieren und betriebsfertig anzuschließen.

Die **Bedienungsanleitung** richtet sich an das Bedienpersonal und entsprechend ausgebildete Fachkräfte für elektronische und mechanische Instandhaltung.

CE-Kennzeichnung

Die Konformitätserklärung steht als Download auf der Homepage von Rittal zur Verfügung.

EN

The **assembly instructions** are aimed at personnel who have completed corresponding technical training and are thus qualified to set up enclosures with electrical, electronic, mechanical and pneumatic equipment in accordance with applicable standards and to erect, assemble and connect such enclosures at the place of use.

The **operating instructions** are aimed at operating personnel and correspondingly trained specialists for electrical and mechanical maintenance.

CE label

The declaration of conformity is provided for download on the Rittal website.

FR

La **notice de montage** s'adresse à toutes les personnes qui possèdent la formation technique suffisante pour le montage, l'installation sur site et le raccordement d'armoires électriques selon les normes électriques, électroniques, mécaniques et pneumatiques en vigueur.

La **notice d'utilisation** s'adresse aux opérateurs et aux spécialistes formés pour la maintenance électrotechnique

Certification CE

La déclaration de conformité peut être téléchargée depuis le site Internet de Rittal.

DE

Verwendete Symbole

Beachten Sie folgende Sicherheits- und sonstige Hinweise in der Anleitung:

Symbol für eine Handlungsanweisung:

- Der Blickfangpunkt zeigt an, dass Sie eine Handlung durchführen sollen.

Sicherheits- und andere Hinweise:



Gefahr!
Unmittelbare Gefahr für Leib und Leben.



Achtung!
Mögliche Gefahr für Produkt und Umwelt.



Beachten!

EN

Symbols used

Observe the following safety and other notes in the instructions:

Symbol identifying required actions:

- The bullet point indicates an action to be performed.

Safety and other notes:



Danger!
Immediate danger to life and limb.



Caution!
Potential threat to the product and its environment.



Note!

FR

Symboles utilisés

Tenir compte des consignes de sécurité et autres directives contenues dans cette notice :

Symbole indiquant une action à effectuer :

- Le pictogramme en caractère gras indique que vous devez exécuter une action.

Consignes de sécurité et autres directives :



Danger !
Risque de blessure grave, voire mortelle.



Attention !
Danger éventuel pour le produit et l'environnement.



Attention !

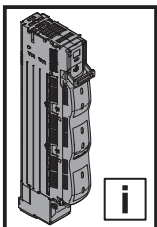

Sicherheitshinweise/Safety notes/Consignes de sécurité

DE



Vor Installation- oder Servicearbeiten Stromversorgung unterbrechen, um Unfälle zu vermeiden. Die Geräte müssen in einem passenden Gehäuse eingebaut und gegen Verschmutzung geschützt werden. Inbetriebsetzung und Wartung nur durch Fachpersonal!

EN



To prevent electric shock, disconnect from power source before installing or servicing. Install in suitable enclosure. Keep free from contaminants. To be commissioned and maintained only by qualified personnel!

FR



Avant le montage et la mise en service, couper l'alimentation secteur afin d'éviter tout accident. Prevoir une mise en coffret ou armoire appropriée, protéger le produit contre les environnements agressifs. Mise en service et entretien : seulement par du personnel spécialisé !

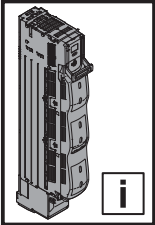

Varianten/Variants/Modèles

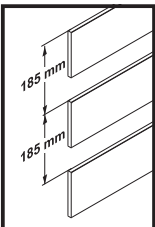
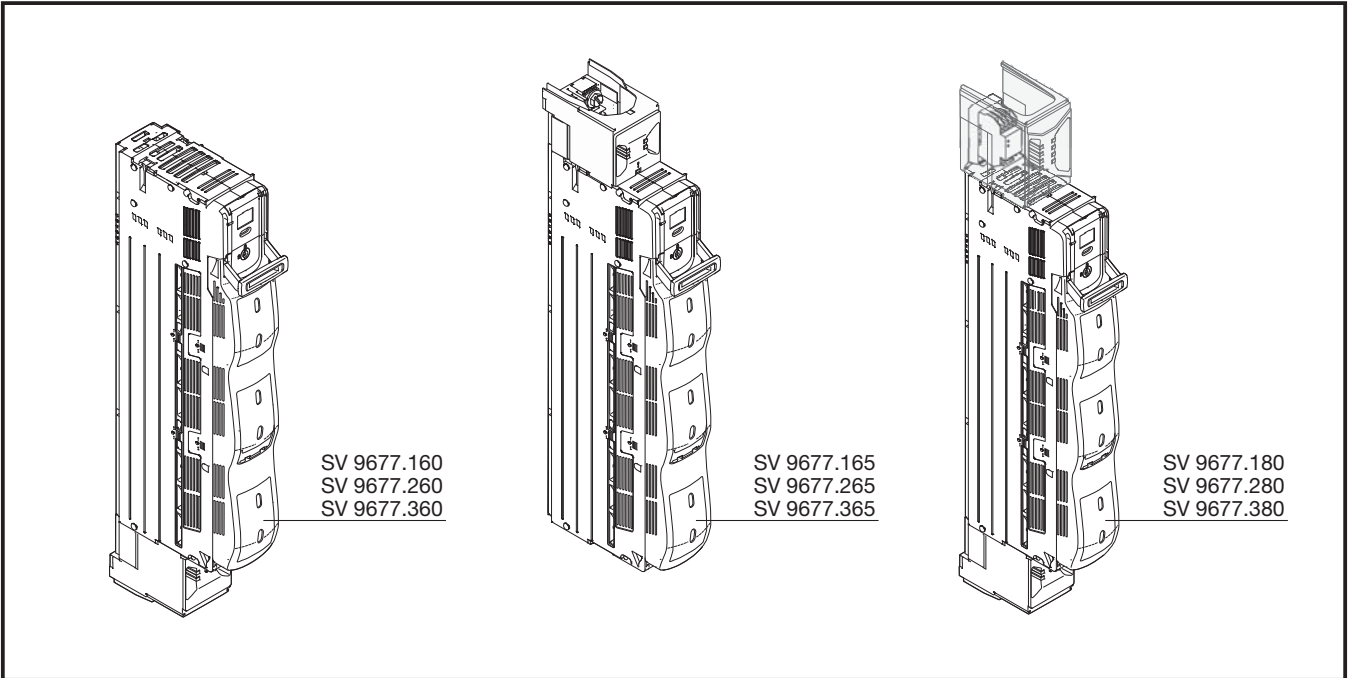

Schienensystem/Busbar system/Jeux de barres

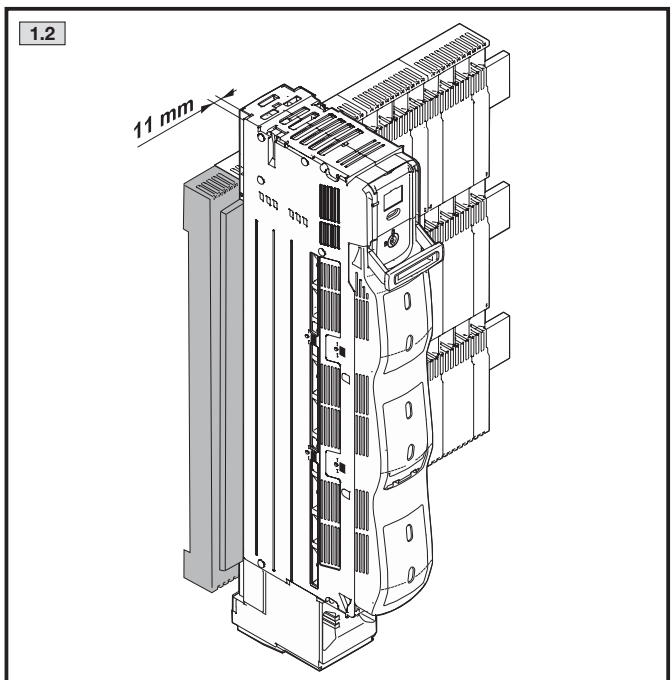
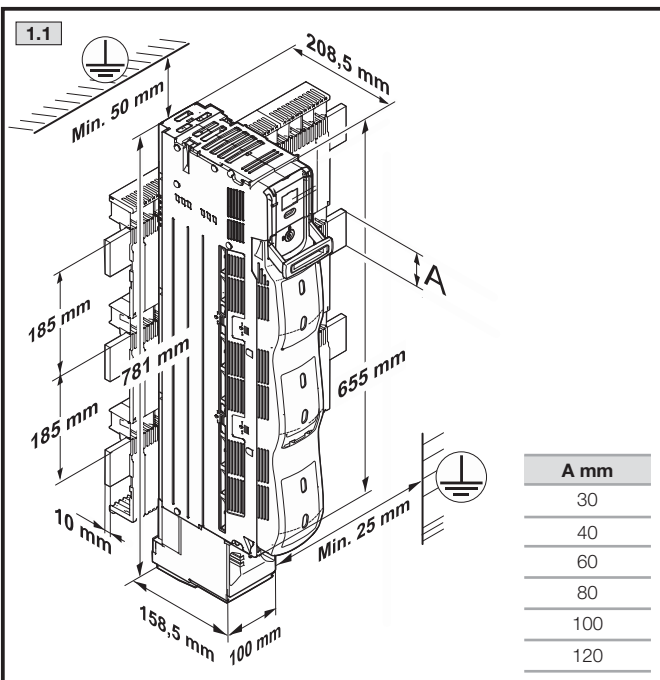

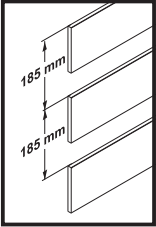

Schienensystem/Busbar system/Jeux de barres

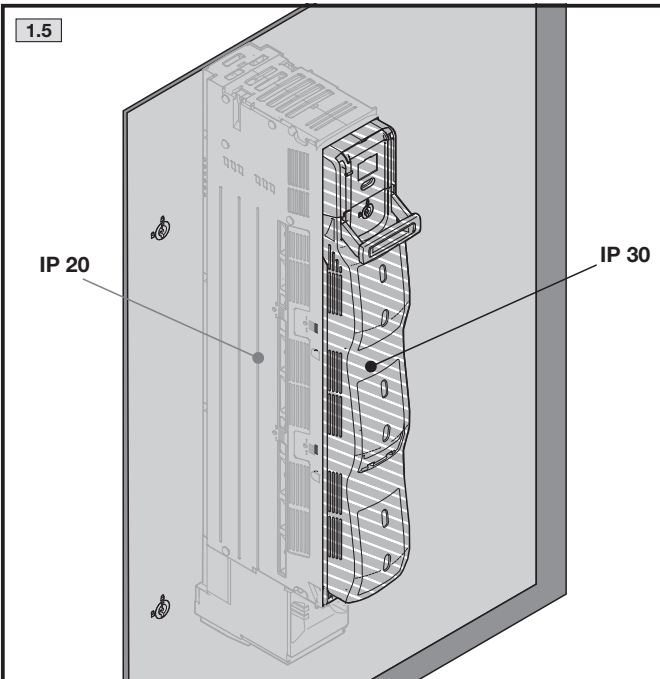
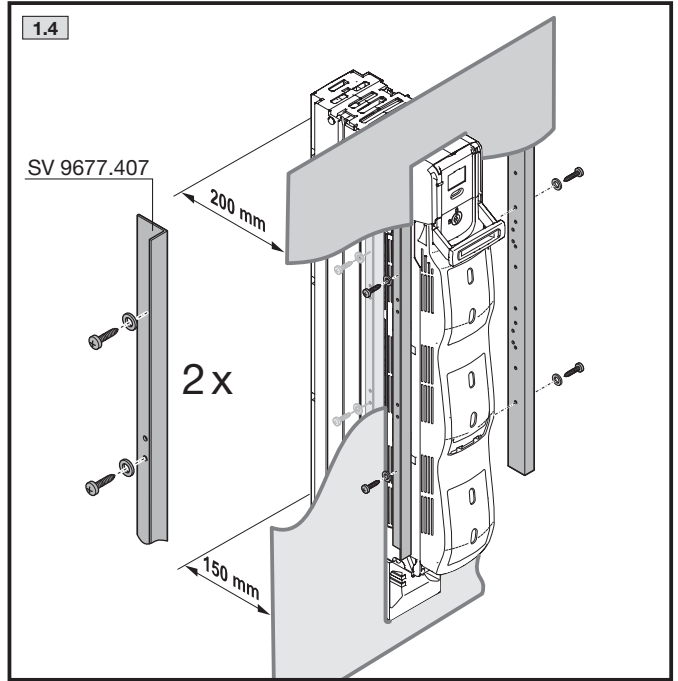
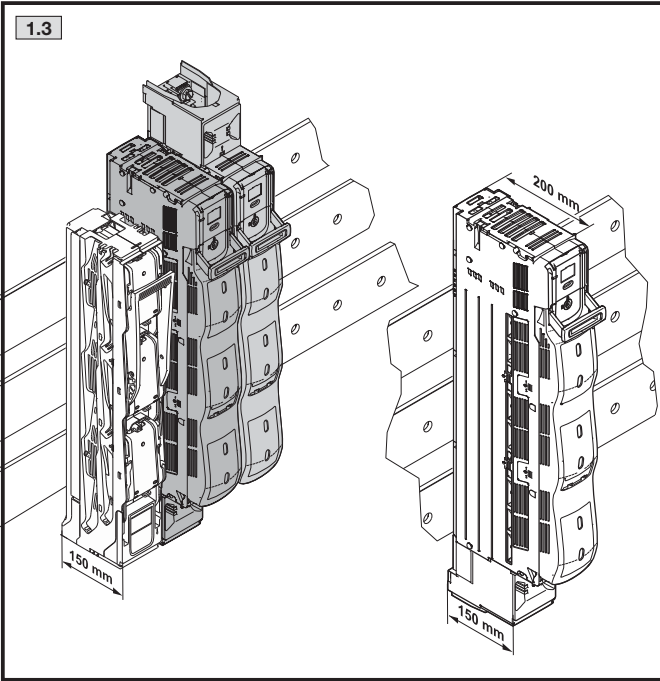

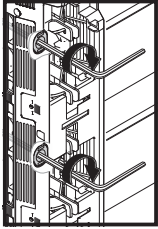

Montage/Assembly/Montage

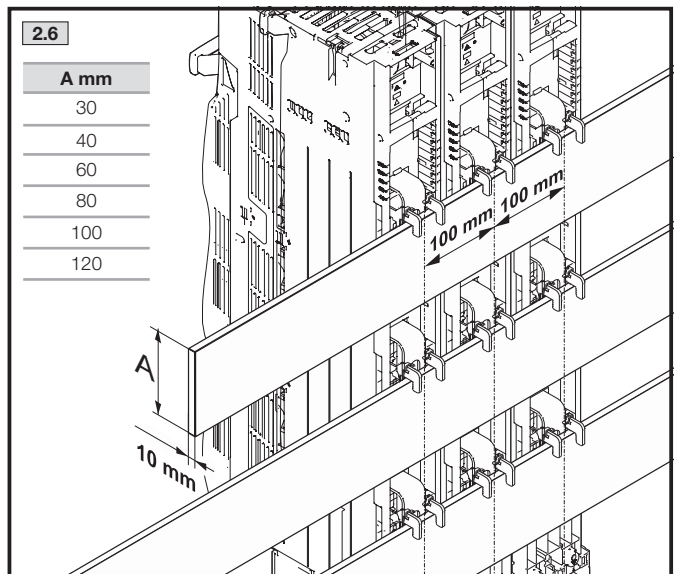
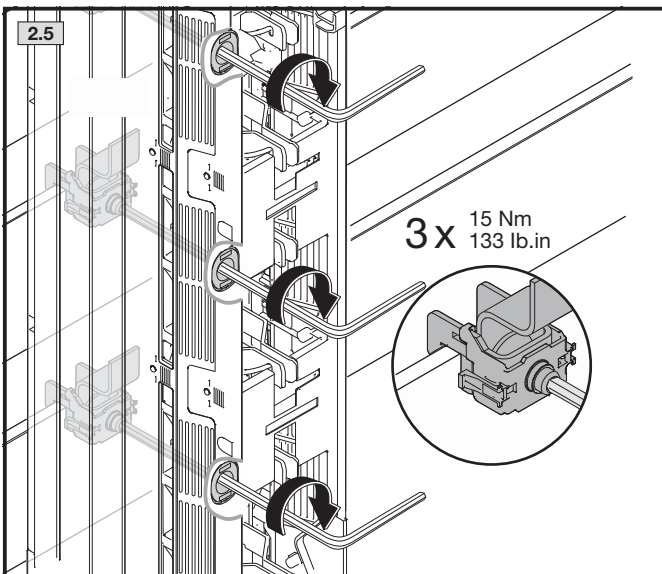
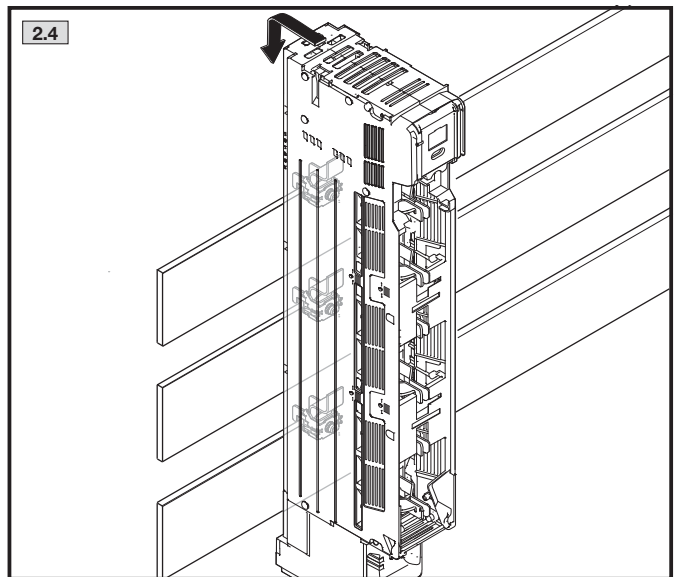
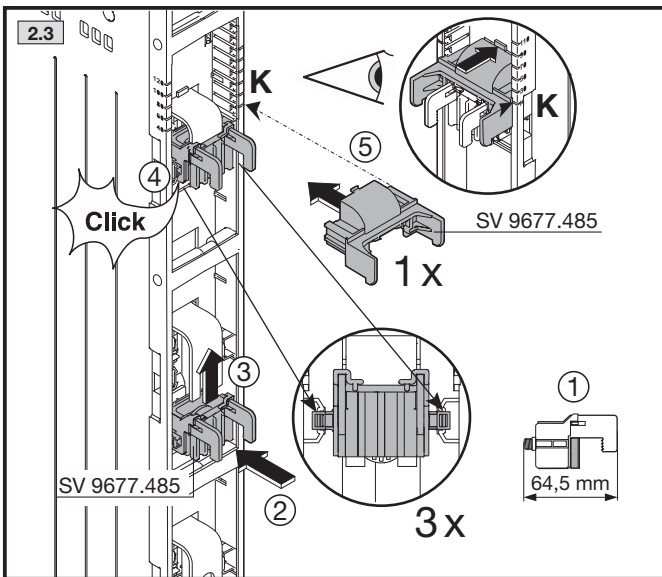
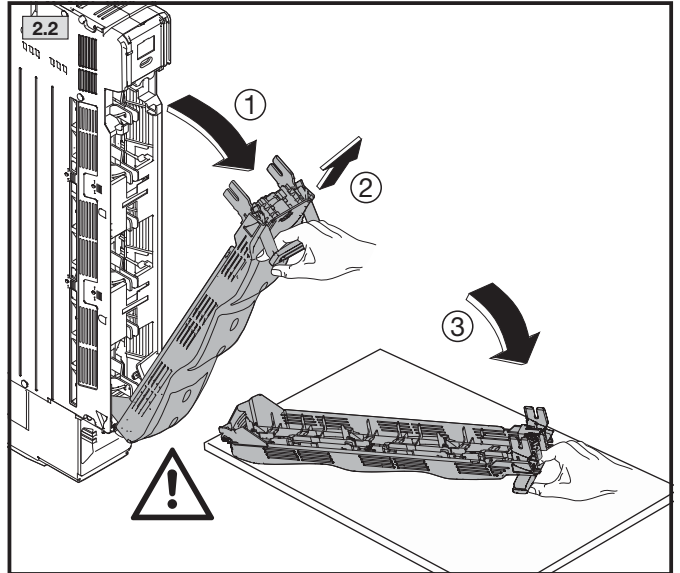
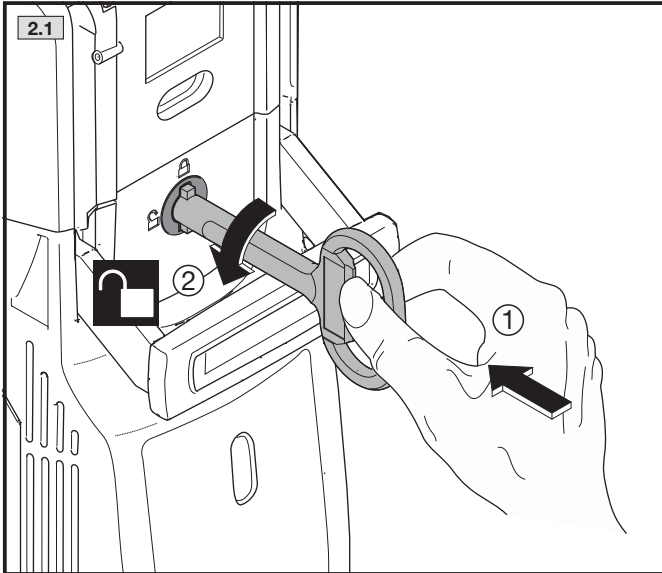

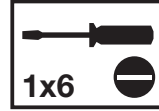
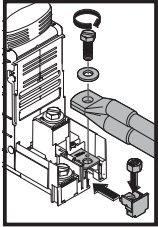

Anschlüsse/Connections/Raccordements

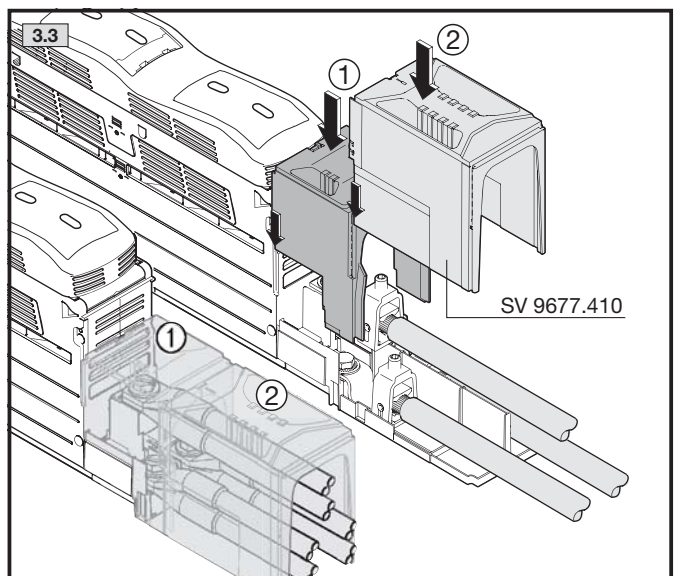
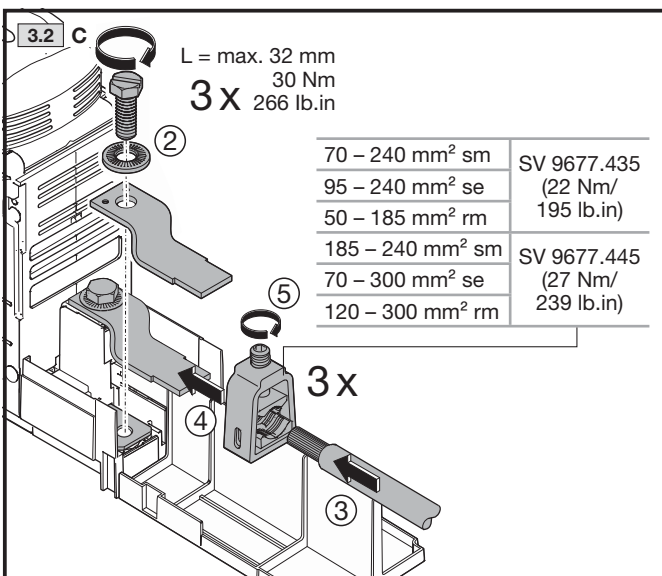
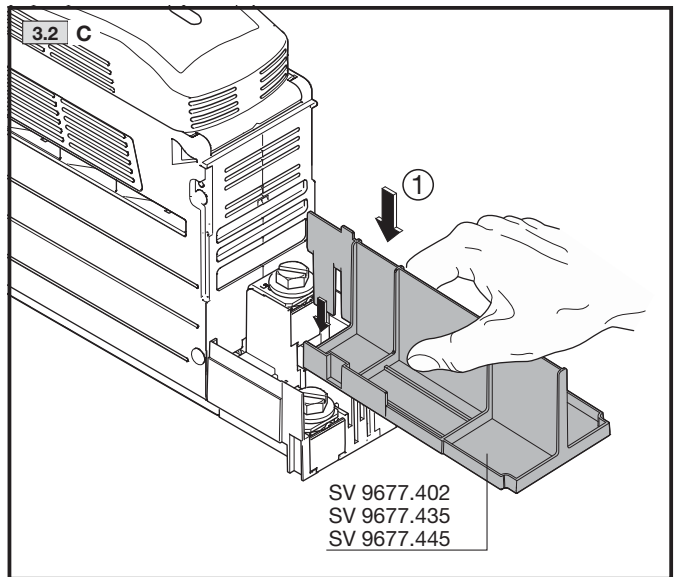
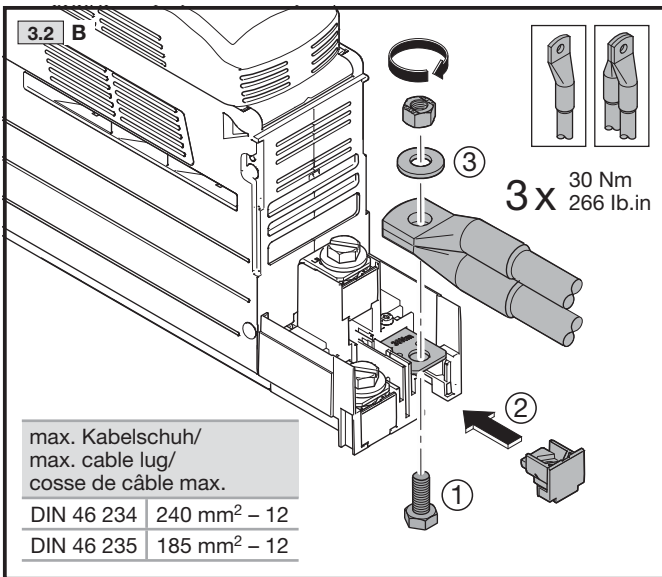
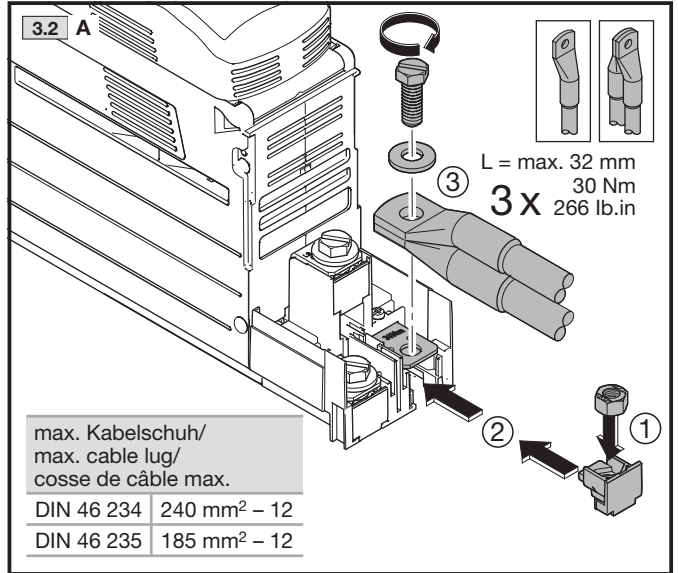
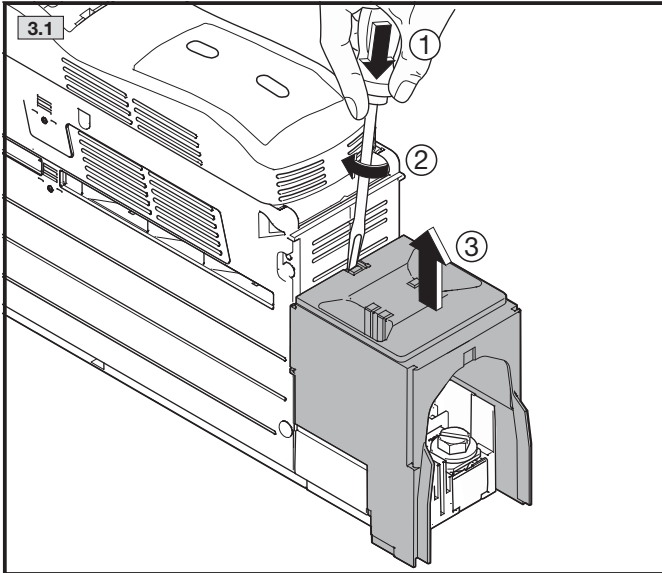

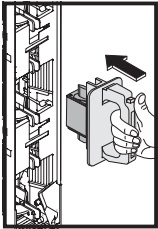

Sicherungen auswechseln/Change the fuse/Remplacement des fusibles

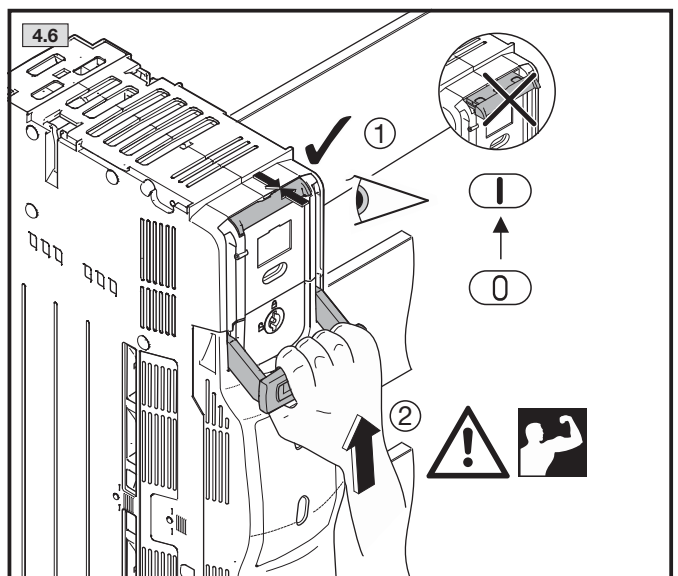
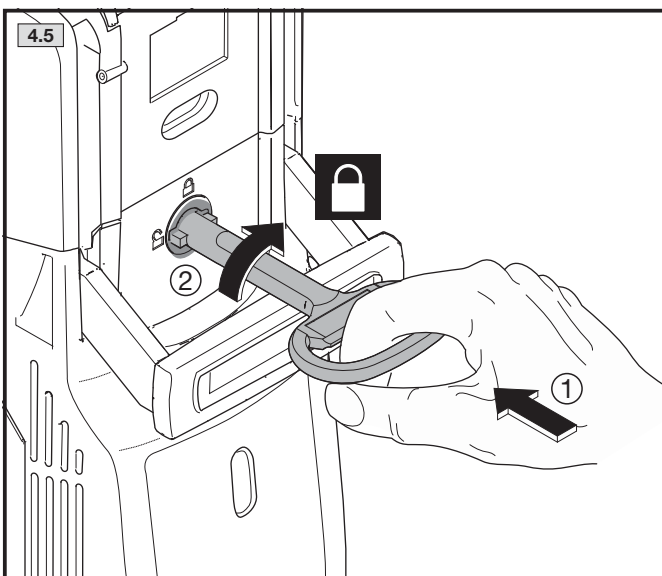
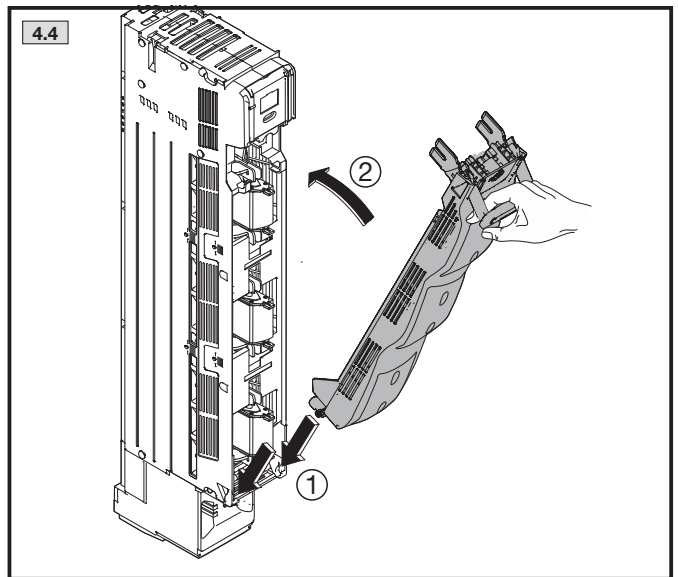
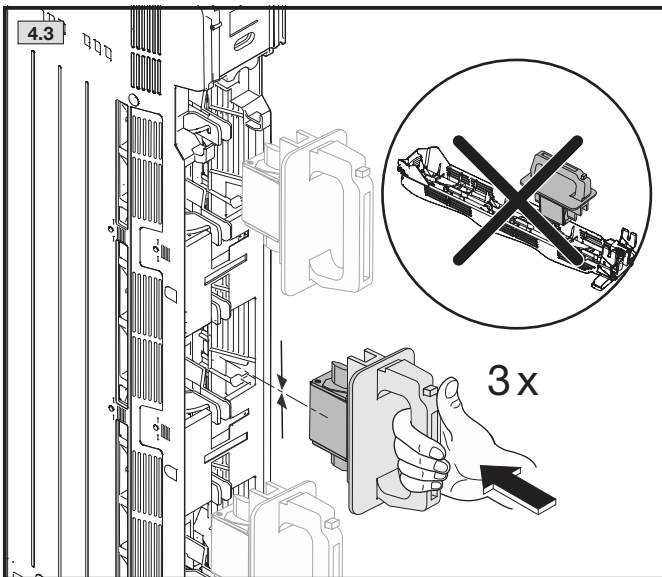
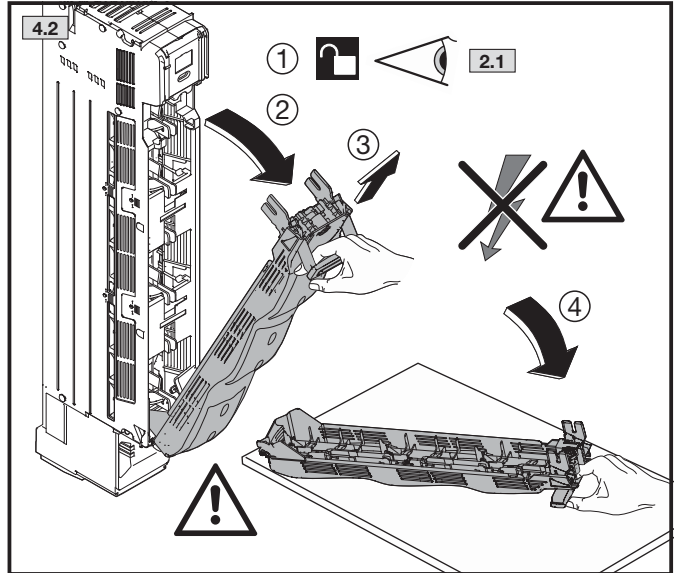
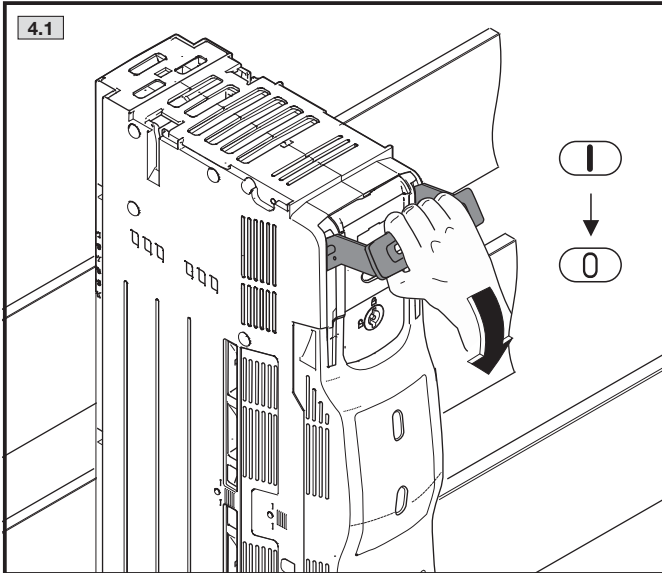

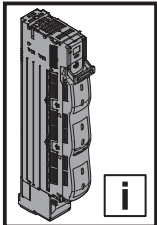

Abschließbarkeit/Locking the fuse holder/Cadenassage

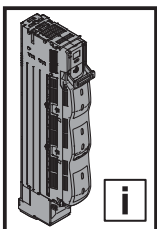
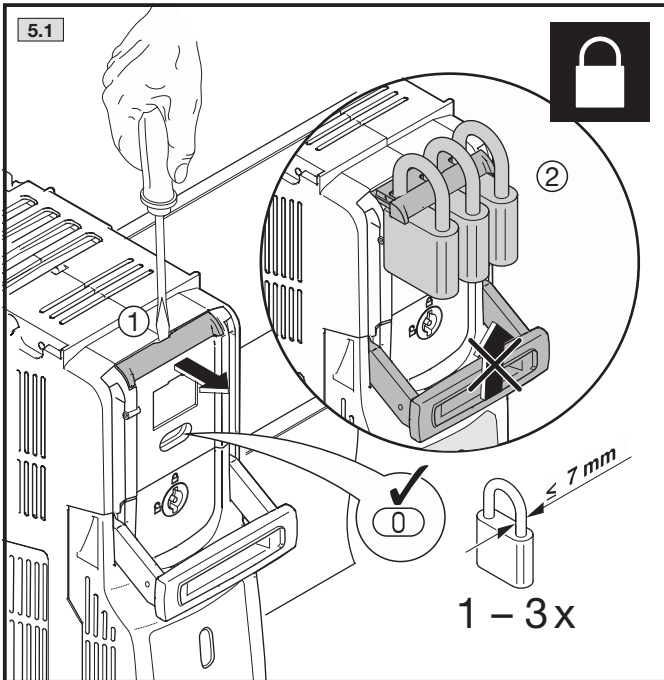

Plombieren/Sealing/Plombage

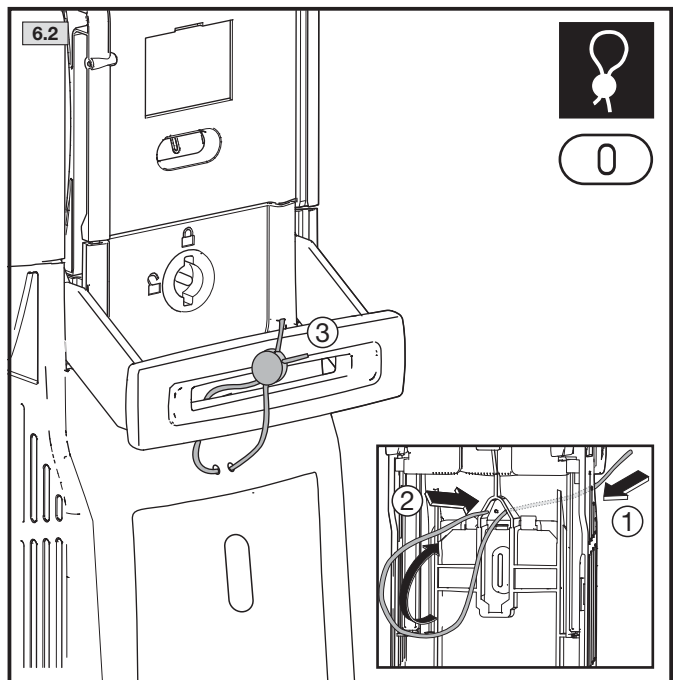
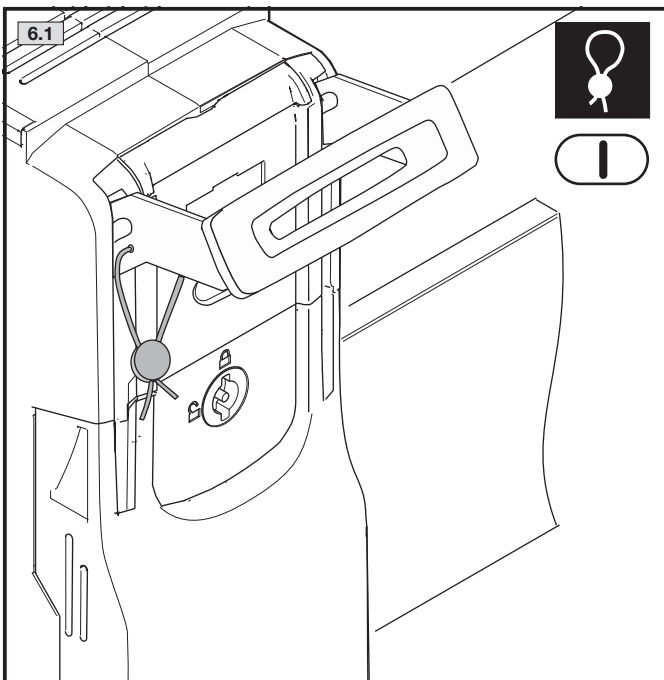

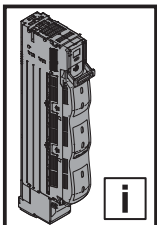

Spannungsprüfung
Voltage test
Test de tension

Parkposition
Parking position
Position d'attente

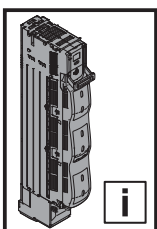
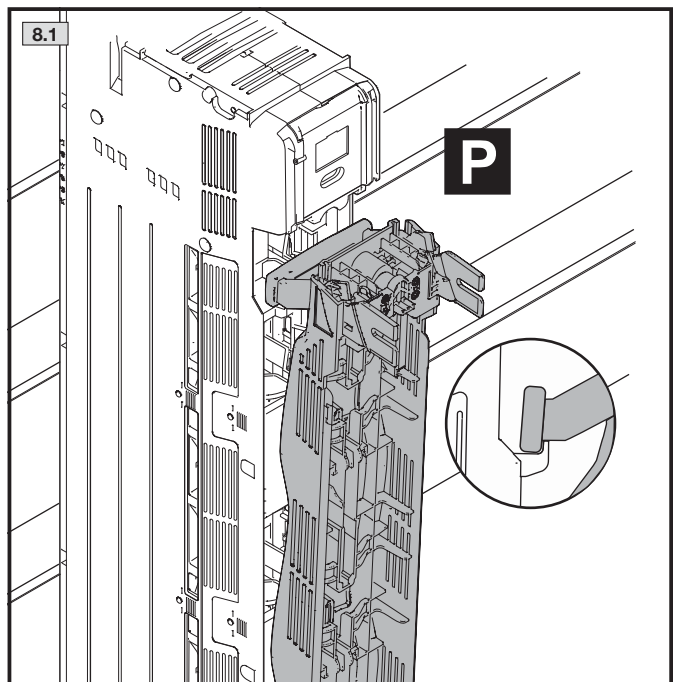
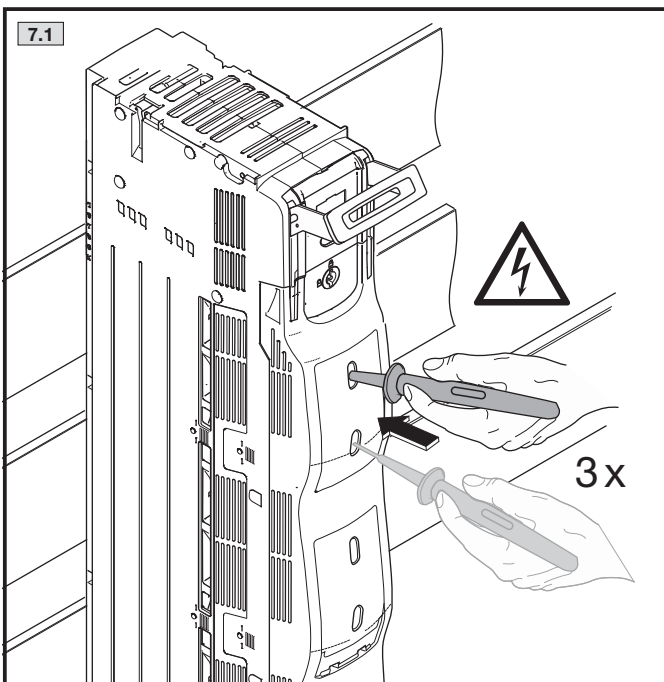

Zubehör – Meldeschalter, Einbau
Accessories – Pilot switch, assembly
Accessoires – Micro-commutateurs, montage à l'intérieur

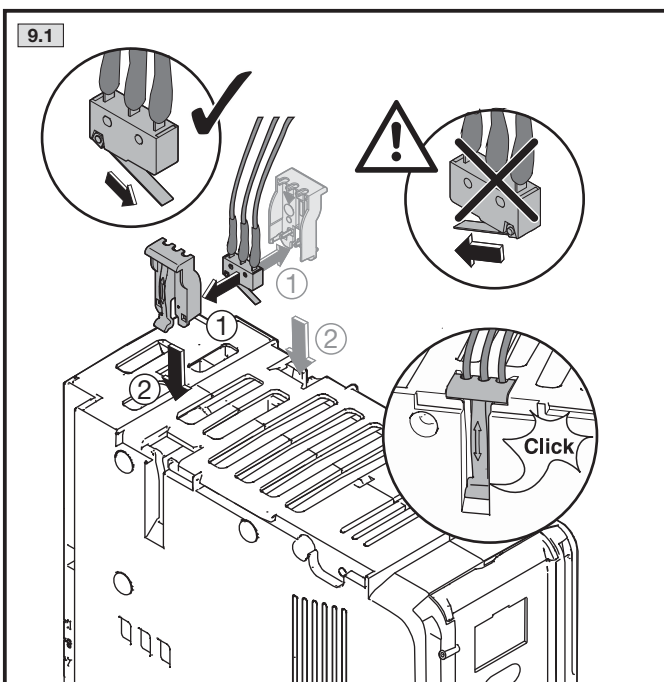

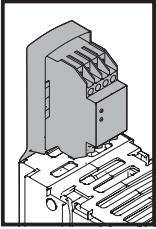

Elektronische Sicherungsüberwachung/Electronic fuse monitoring/ Surveillance des fusibles électroniques

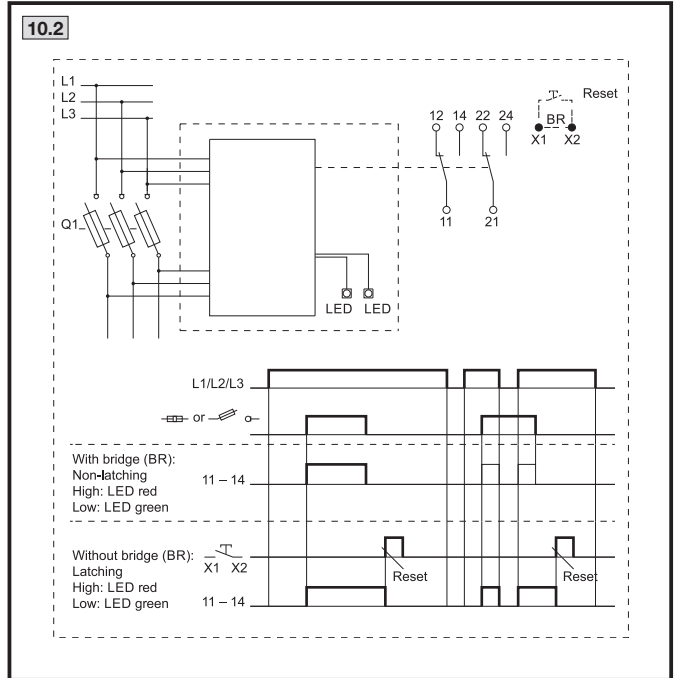
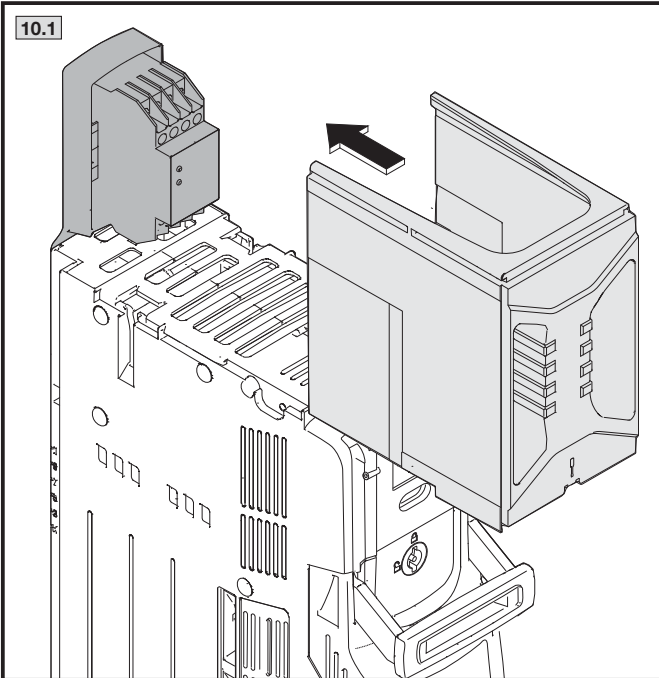

Rittal – The System.

Faster – better – everywhere.

- Enclosures
- Power Distribution
- Climate Control
- IT Infrastructure
- Software & Services

You can find the contact details of all Rittal companies throughout the world here.



www.rittal.com/contact

02.2017/D-0000-00000667REV/01

ENCLOSURES

POWER DISTRIBUTION

CLIMATE CONTROL

IT INFRASTRUCTURE

SOFTWARE & SERVICES

FRIEDHELM LOH GROUP

